

3M™ Speedglas™ Welding Safety
Product Catalogue 2013/2014



 **Speedglas™**

Passion for Welding

The Power to Protect Your WorldSM





3M™ Eye, Face and Head Protection for Welders

Speedglas™ Welding Helmet Series 9100	6
Speedglas™ Welding Helmet SL	16
Speedglas™ Welding Helmet Series 100	18
Speedglas™ Welding Helmet Series 9000	22
Safety helmet option for Speedglas™ Welding Helmets	23

3M™ Respiratory Protection for Welders

Adflo™ Powered Air Respirator	24
Versaflo™ Supplied Air Regulator V-500E	28
Protective Visor Respirator Systems	30

Frequently Asked Questions	32
Parts Directory	40
Care and Maintenance	62
Technical Specifications	63
Product Index	66



Bigger Views & Multi Protection – Page 15



Our Lightest Welding Helmet – Page 16



Designed for Welders' Needs – Page 24



Speedglas Graphic Edition – Page 20



More than 35 years ago, we went to the shipyards of Sweden to study welders working situation. We found skilled craftsmen blindly striking arcs as they continually nodded their shields down. Since then, our company has committed to develop tools that forever change the world of the welder. From the first groundbreaking auto-darkening welding helmet in 1981 to our current line up of state-of-the-art welding safety products, we continue to revolutionize your world.

Inspired by your reality

We have a passion for welding and we know the challenges of your profession. It comes natural for us to share the pride and concern you put into your work to address the ergonomic and safety issues facing you every day.

Your thoughts and opinions are the bottom line in our continuous search for innovation. Inspired by your reality, we shape the future of welding so you can get on with the job of shaping ours.



3M™ Speedglas™
Welding Helmet 9100 MP with
3M™ Adflo™ Powered Air Respirator



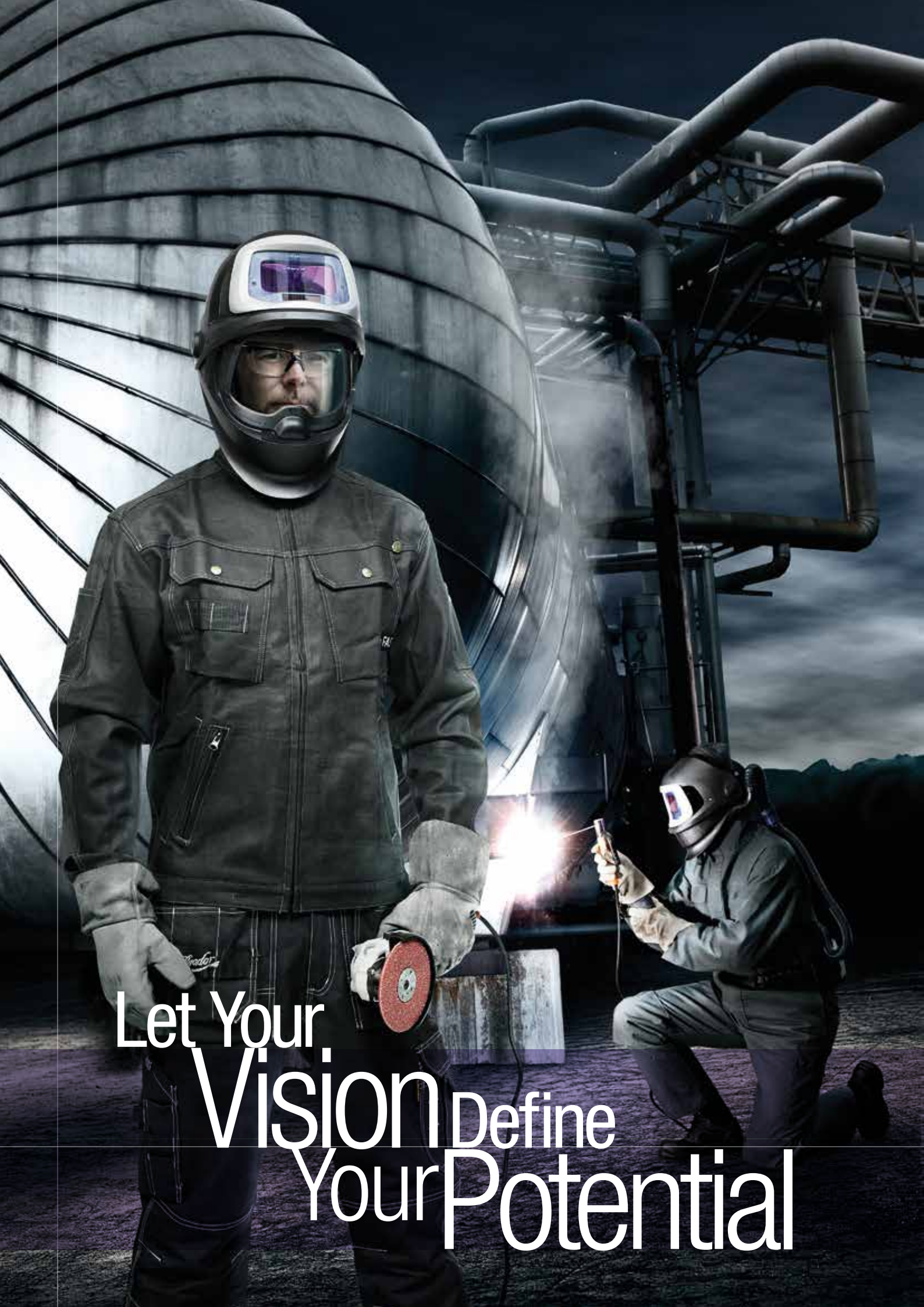

Let Your
Vision Define
Your **Potential**

When you're already the standard for others to follow, innovation is the way to keep the lead. All our welding helmets and protection equipment benefit from our commitment to constant development. The future of welding? You're holding it in your hands.



3M™ Speedglas™ Welding Helmet 9100



3M™ Speedglas™ Welding Helmet 9100 FX



3M™ Speedglas™ Welding Helmet 9100 Air

Experience the Difference!

Professional welders marvel at our top-of-the-line 3M™ Speedglas™ Welding Helmet Series 9100. We pursue challenge with passion.

- Superior comfort.
- Increased balance and stability.
- Excellent optics and bigger views.
- Increased coverage.
- Flip-up welding helmets with clear protective visor.
- Respiratory welding helmet options.
- New multi-protection system: 3M™ Speedglas™ Welding & Safety Helmet 9100 MP with respiratory protection.



3M™ Speedglas™ Welding Helmet 9100 MP

Can't wait for the future?

Call your local 3M distributor for a hands-on demonstration.



3M™ Speedglas™ Welding Helmet 9100 FX Air

3M™ Speedglas™ Welding Helmet 9100 Series

The headband that shapes to your head

All welding helmets in the Speedglas 9100 series feature a highly adjustable, comfortable headband. The outside of the human head is lined with nerves, arteries, and acupressure points; applying pressure to some of these spots actually makes a person feel fatigued. The 9100 headband specifically

avoids these vulnerable areas. And it provides multiple adjustment combinations so you can “tailor” the helmet to fit your personal preferences and comfort settings. Less pressure — and a perfectly-adjusted, personal fit — means more comfort, all day long.

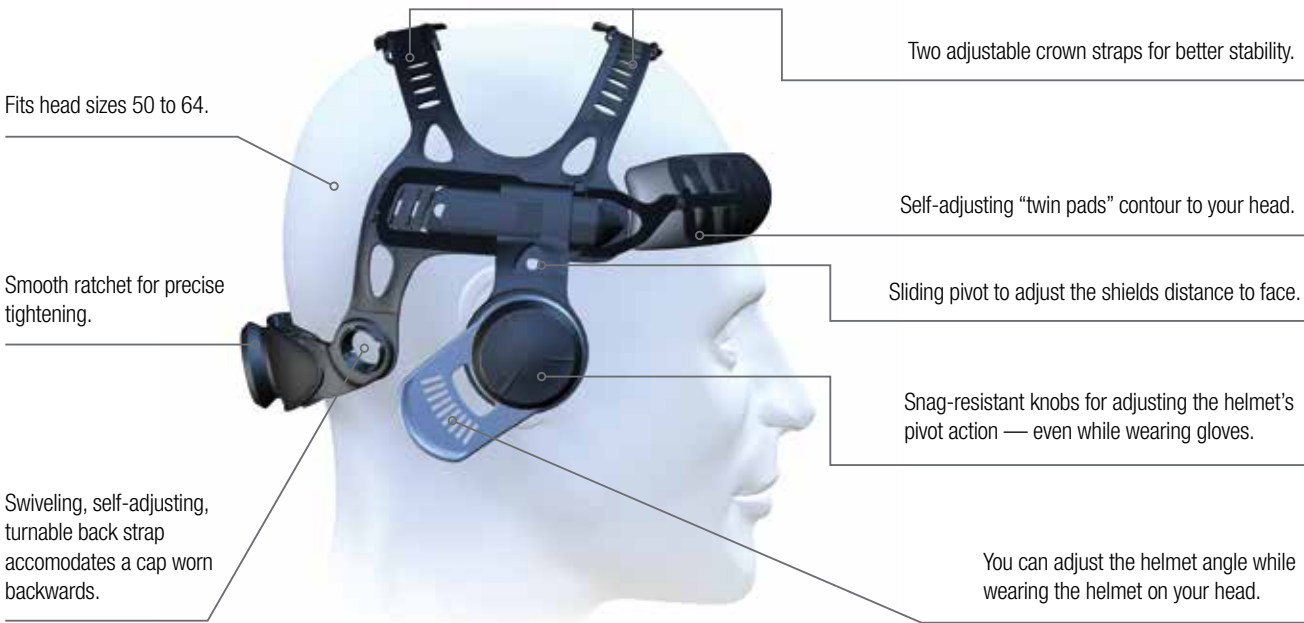

More comfortable when raised

Lifted into the raised position, the helmet’s “high point” is lower than many other helmets. From a design standpoint that means keeping the helmet as close as possible to your head.

Because the helmet is more balanced, you do not need to tighten the headband as much, further increasing your wearing comfort.

“Parking” position

The smooth up-and-down pivot action can be “locked” in the up position — a light pull lowers the helmet back down again.



Excellent Optics, Bigger Views

The 3M™ Speedglas™ Welding Filter Series 9100 continue our tradition of outstanding optical quality, including uniform shading and minimal distortion across the entire filter viewing area. By selecting just the right setting for each task, you reduce eye strain and improve the quality of every weld.

- The Speedglas welding filter 9100XX is 30% larger than any other Speedglas welding filter.
- Seven dark shades, including 9–13 (variable), 5 for gas welding/cutting, and 8 for micro-plasma or low-amp TIG.
- Outstanding low-amp TIG performance, even on settings as low as 1 amp.
- Any shade can be “locked-in.” For example, you can lock-in the light state shade 3 for grinding.
- Exclusive, innovative tack welding comfort mode which can help reduce eye strain.



Magnification made easy. The magnifying lens holder is built into the welding filter, making lens installation easier and more secure.

Seven user selectable dark shades for most types of arc welding.

Conforms to European Standard EN 379 personal eye-protection – automatic welding filters, as well as other national standards in USA, Canada, Australia — to name a few.

The helmet series 9100 include three auto-darkening filters: regular, large, and extra-large viewing area.

The tack welding comfort mode uses an intermediate shade 5 light state to help minimize eye strain during extended tack welding applications.

The Delay function allows you to set the dark-to-light switching time.

You can adjust the sensitivity of the arc detection for unsurpassed switching reliability.

3M™ Speedglas™ Welding Helmet 9100

Designed for Ultimate Protection

Protecting your eyes and face from radiation, heat and sparks — while providing a precise view of your work — makes your Speedglas welding helmet 9100 one of your most important welding tools.



A selection of welding filters with superior optical performance for continuous viewing comfort. Arc detection down to 1 amp TIG.

With the new type of safety helmet adapter (accessory), you can easily fit the industry's most popular safety helmets with the Speedglas welding helmet 9100.

Ultraviolet (UV) and infrared (IR) protection at all times, in all states.

Exhaled air is channelled out via side exhaust vents.



High-comfort Speedglas Headband 9100.

Increased coverage for ear and side of head.

SideWindows: Shade 5 filters that widen your field of vision.

Meets the requirements of mechanical resistance to high speed particles according to EN 175 class B.



Exhaust vents: Readily directs your exhaled air out of the helmet and reduces the likelihood of a foggy welding filter.



3M™ Speedglas™ Welding Helmet 9100 Air

Respiratory Welding Helmet

All of the benefits of the 9100 welding helmets can now be used in combination with powered or supplied air respiratory protection. See further details of respirator compatibility on page 53

Speedglas welding filter series 9100 with superior optical performance for continuous viewing comfort.

Meets the requirements of mechanical resistance to high speed particles according to EN 175 class B.

The all-new face seal readily follows the contours of both the helmet and your face.



An airduct that is an integral part of the helmet, providing a refreshing airflow across your entire breathing zone.

SideWindows: Shade 5 filters that widen your field of vision.

The innovative 3M™ Quick Release Swivel (QRS) enables one-handed breathing tube connection and release.



Airflow: The middle channel keeps the filter virtually fogfree, while two side channels provide smoothly distributed air to the area of your mouth and nose.

Extended protection:

A flame-resistant headcover (used in this application) and an ear/neck protection are available as accessories.



3M™ Speedglas™ Welding Helmet 9100 FX

Wider Field of View with Flip-Up Front

Speedglas welding helmet 9100 FX, a flip-up combination of an auto-darkening welding helmet and a protective visor. Not only is the viewing area larger compared to previous

models, we totally redesigned the geometry of the helmet for a wider field of view in all directions.

With the new type of safety helmet adapter (accessory), you can easily fit the industry's most popular safety helmets with the Speedglas welding helmet 9100 FX.



100% compatible with our top-of-the-line series of Speedglas welding filter series 9100.

SideWindows: Shade 5 filters that widen your field of vision.

High-comfort Speedglas headband 9100.

Exhaled air is channelled out via side exhaust vents.

The big, 17 x 10 cm clear protective visor is curved, increasing your peripheral vision.

Meets the requirements of mechanical resistance to high speed particles according to EN 175:B and EN 166:B.



A spark- and spatter-resistant fabric head cover is standard on all 3M™ Speedglas™ Welding Helmets Series 9100 FX.

3M™ Speedglas™ Welding Helmet 9100 FX Air

Improved Respiratory Protection – TH3!

For constant TH3-rated respiratory protection and excellent vision in a flip-up model — meet the Speedglas welding helmet 9100 FX Air.

It readily connects both powered and supplied air respirator systems. See further details of respirator compatibility on page 54.



To achieve its high level of respiratory protection, air is supplied directly to the breathing zone. A diffuser spreads out the airflow for your maximum comfort.



A quick lift of the silver front and you get a big, 17 x 10 cm, clear view — perfect for precision grinding in low light conditions, while maintaining respiratory protection.

Head Protection without Compromises

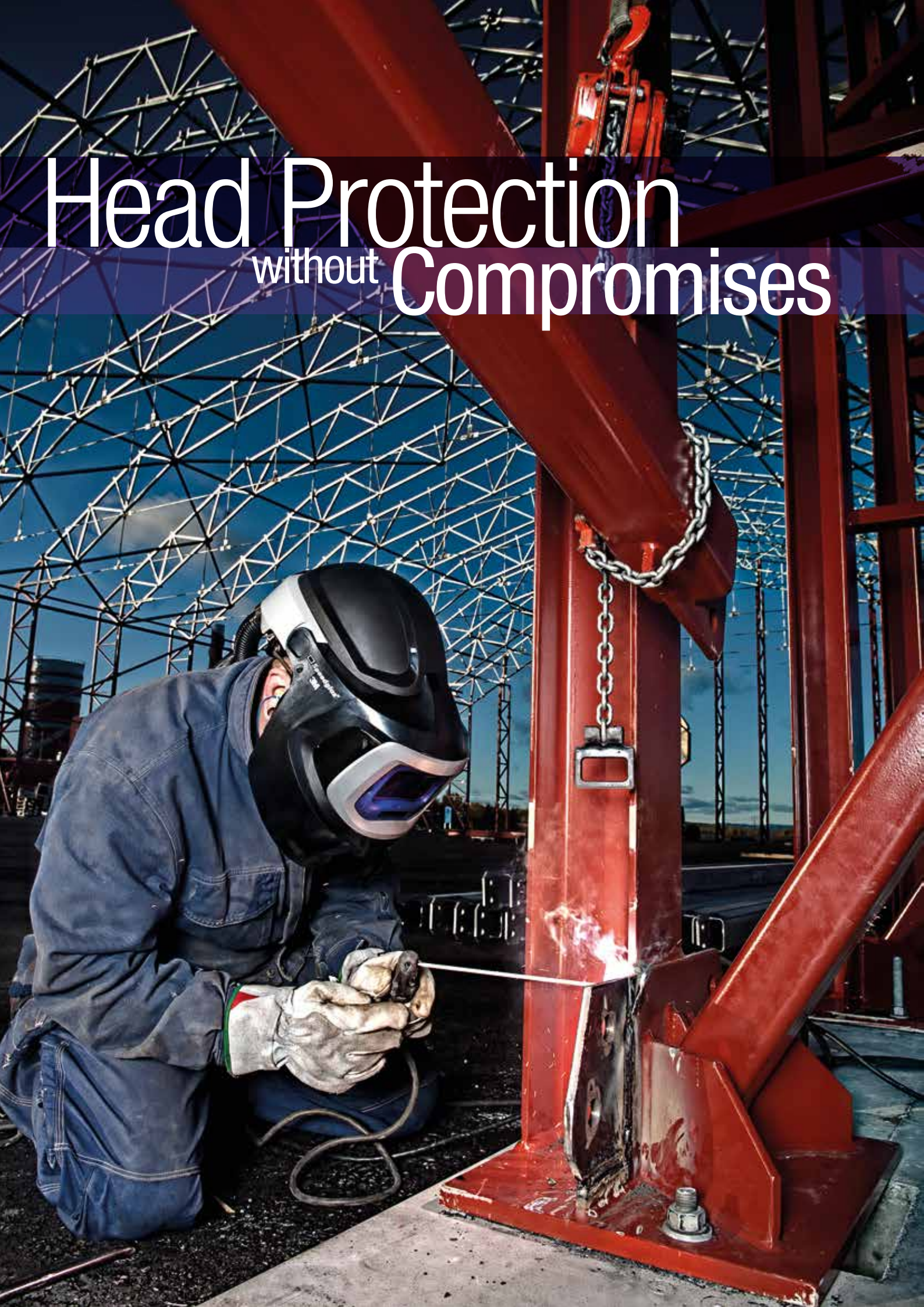

3M™ Speedglas™ Welding Helmet 9100 MP

The Most Advanced Feature Set Available

Introducing the Speedglas welding helmet 9100 MP (Multi-Protection). We've seamlessly integrated five levels of welder protection: head, eye, face, respiratory and hearing into one extraordinarily comfortable and

easy-to-use system. The 9100 MP helmet: uncompromising, all-in-one, welding protection for highly demanding environments.

100% compatible with all Speedglas welding filter series 9100, including the top-of-the-line 9100XX filter.

A big (17x10 cm), curved, protective visor with excellent views up, down and peripherally. Meets EN 166:BT for high speed particle protection*

Two shade 5 passive SideWindows add peripheral welding vision.

The top shell is made from heat resistance polycarbonate and meets the standard EN 397 for industrial safety helmets.

An optional, high-visibility, aluminum fabric reflects hot sunlight and welding heat.



Designed from inception to take one of our optional 3M™ Peltor™ Earmuffs.

* European Standards classify this helmet as "B," with resistance to high speed particles at medium energy impact (120 m/s).



Look Around... Really Look Around

The clear protective visor is wide (17x10 cm), curved and offers great views up, down and side-to-side. It's perfect for prepping and inspecting welds...and just walking around your facility with full-time, TH3-class respiratory protection. Then, pull down your welding shield and appreciate the SideWindows views: you can have peripheral vision at all times, even when welding.



“I forget I’m
Wearing it”

3M™ Speedglas™ Welding Helmet SL

When Your #1 Priority is Super Light

At a mere 360 grams — including its auto-darkening filter — the Speedglas welding helmet SL is 25% lighter than any other Speedglas model.



Our narrowest helmet: perfect for many super tight spaces.

Five adjustable dark shades 8–12 and a light shade of 3. Four sensitivity settings.

Grab & Go: A motion sensor automatically turns ON the welding filter when you pick up the helmet.

Appropriate for most arc welding processes — such as MMA, MIG/MAG, TIG and plasma welding.



Quick and light, perfect for fast tasks

Using specialised manufacturing techniques, we greatly reduced the weight of the auto-darkening filter. And unlike other lightweight helmets that can absorb moisture and become heavy, the Speedglas helmet SL is made from a strong, non-absorbent material.

Designed specifically for quick welding tasks, a motion sensor automatically turns ON the welding filter when you pick up the helmet.





Premium Made
Affordable

3M™ Speedglas™ Welding Helmet Series 100

High-End Features, Low-End Price

Speedglas welding helmet series 100 allow you to take advantage of excellent optical quality and reliable light-to-dark switching at a highly affordable price.

In addition to the black model, you can choose from several highly expressive graphic helmet designs.

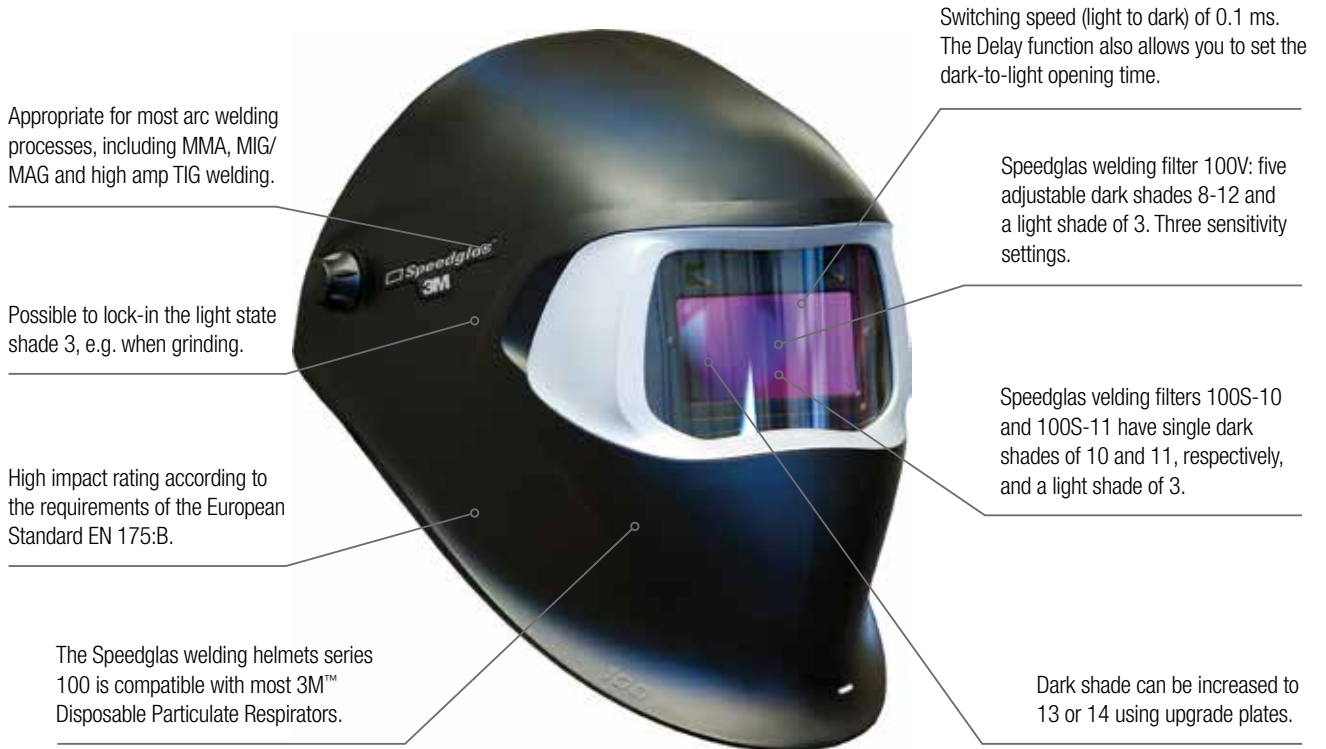

Performance made simple

The easy-to-use Speedglas welding helmet 100 is the ideal auto-darkening helmet for the occasional welder. Hobby welders, farmers, DIY types, and maintenance and construction workers can all benefit from the ability to always clearly see with their welding protection in place. In addition to the black/silver helmet, we offer a series of stunning graphic helmets — each with a unique personality.





Image is
Everything

Make a Visual Impact

3M™ Speedglas™ Graphic Welding Helmet Series 100

Speedglas welding helmets 100 deliver impressive protection and performance with distinctive graphic designs — all with a specific identity.



NEW
Future
Combatant



Ice Hot



Xterminator



Razor
Dragon



Raging
Skull



NEW DESIGN

Trojan
Warrior



Blaze



Aces High

Female Graphic Edition

Inspired by women welders, 3M launched the first line of women specific designs. Our design team took direct inspiration from women welders to work with intricate patterns and graphics. The resulting designs are an avenue for personal expression.



Steel Rose

Toughness and patinated grace. Strong, fearless, and feminine at the same time. Steel aesthetics emphasize the protective qualities of the helmet.

Designed by Veryday



Wild-N-Pink

Pretty in pink, but do not touch! A vivacious vine flourishes behind a protective overlay of barbed wire and razor-sharp metal sculpture. Admire from a distance.



Skull Jewels

An elaborate floral grill motif emerges into a decorative skull and covers the entire helmet. The skull and flowers engage in visual interplay as one becomes the other, and vice-versa.

Designed by Veryday



Steel Eyes

Projecting inner strength, with focused eyes looking through a blaze of lilac flames.

Designed by Veryday

3M™ Speedglas™ Welding Helmet 9000

Our Classic Welding Helmet



The Speedglas welding helmet 9000 is still available with 3M™ Speedglas™ Welding Filter 9002D (previous variable shade models 9002V and 9002X filters and Speedglas welding helmet 9000 FlexView are now replaced by the 3M™ Speedglas™ Welding Helmet Series 9100. See page 6 for more details of the 9100 product line.

- Available as complete welding helmet with Speedglas welding filter 9002D, which has dual dark shades 9 and 11. The Speedglas welding filters 9002V and 9002X can still be ordered as spare parts.
- Speedglas SideWindows option.
- Exclusive helmet exhaust vents.

3M™ Speedglas™ Welding Helmet 9000 ProTop

For Overhead Hazards

The key to the Speedglas welding helmet 9000 ProTop is the innovative pivot mechanism that connects the welding helmet to its safety helmet. The mechanism keeps the helmet close to the helmet at all times, for excellent balance and reduced strain on your neck muscles.

- Available with Speedglas welding filter series 9002, variable shade 9-13 or dual shade 9/11.
- Speedglas SideWindows option.
- Exclusive welding helmet exhaust vents.



3M™ Speedglas™ Welding Helmet 9000 ProTop with safety helmet has a special low profile design with minimal projections, so it is less likely to snag on surrounding obstacles. The flat front of the safety helmet features a short brim, so the welding helmet can be close-to-the-face for optimum viewing.



Safety Helmet Option for 3M™ Speedglas™ Welding Helmets

Welders working in areas with overhead hazards can now benefit from the new safety helmet options for 3M™ Speedglas™ Welding Helmets 9100, 9100 FX and 100.

The 3M™ Safety Helmet G3001 is made of high quality UV-stabilised, ABS-plastic. One of the lightest safety helmets on the market, the G3001 helmet has top ratings for absorbing and distributing the forces of falling objects.

Can also fit other types of safety helmets!

Using our new safety helmet adapter, you can easily fit the industry's most popular safety helmets with the Speedglas welding helmet 9100. See the safety helmet adapter compatibility list (at right).



Safety Helmet Adapter Compatibility for 3M™ Speedglas™ Welding Helmet 9100

3M™ Safety Helmet H701
3M™ Safety Helmet G22
3M™ Safety Helmet G3001
MSA Safety Helmet V-gard® *)
3M™ Safety Helmet 1465 Balance *)
Centurion® Vulcan™ Safety Helmet *)
Schubert® BEN™ and BOP™ series Safety Helmets *)
Protector® HC 43 Tuffmaster™ Safety Helmet *)
Unisafe® TA560 UniLite™ Safety Helmet ABS *)
3M™ Safety Helmet 2000/2010

*) Non 3M manufactured safety helmets: Tests have been made to ensure that our safety helmet adapter for Speedglas welding helmet 9100 will fit the safety helmets listed in this table. 3M does not control future changes made to safety helmets not manufactured by 3M. All trademarks, service marks, product names, and company names cited here are the property of their respective owners.



Safety helmet adapter for 3M™ Speedglas™ Welding Helmet 9100.
Part No 19 71 35

3M™ Speedglas™ Welding Helmet 9100 with safety helmet adapter and 3M™ Safety Helmet G3001. A Uvicator is built into the G3001 helmet. When the helmet is new the Uvicator is red, as UV-radiation takes its toll on the plastic, the red Uvicator gradually fades out. When the red has faded away completely, it is time to replace the helmet.

3M™ Adflo™ Powered Air Respirator

Cooler, cleaner and more comfortable welding

Since its launch 13 years ago Adflo has become one of the most popular powered air respirators in the world. The Adflo powered air respirator is specially designed to meet your welding needs. Its continuous airflow provides filtered air that takes much of the heat and sweat out of welding. By using the Adflo respirator, you get both increased protection and comfort all day long.

Full mobility

The slim profile and ergonomic design makes it easier to go into tight welding spaces and offers the quality and functions you should expect from a robust and easy-to-use respiratory protection. The new Li-ion batteries makes it even more lightweight and balanced for even greater comfort during the full shift.

An adaptable system that saves money

With the right type of filter, the Adflo respirator effectively protects you against both particles and gases — all in one



system. And you can selectively replace either the particle or the gas filter as needed: you don't need to change both filters at the same time.

Constant flow of clean air

The airflow is always a constant nominal rate of 170 litres per minute, regardless of the battery's charge or the particle loading of the filter. For hot, humid jobs, you can increase the airflow to 200 litres per minute by simply pushing the ON button a second time.

Higher altitudes

For welders working in higher altitude locations, where the regular Adflo respirator might not work properly, there is a special respirator version that adjusts for changes in air density; 3M™ Adflo™ High Altitude Powered Air Respirator.

With this version you can work at altitudes up to three times higher than the regular Adflo respirator.



- A Filter cover:** holds the user-replaceable spark arrestor.
- B Prefilter:** increases the service life of the particle filter.
- C Particle filter:** high efficiency particulate filtration.
- D Gas filter:** (A1B1E1 or A2) captures organic, inorganic and acid gases and vapours. Gas filters sold separately.
- E Odour filter:** removes unpleasant smells (not needed if a gas filter is installed); sold separately.
- F Li-ion battery:** fully charges in 4,5 hours. Expected operating time is 8 hours with new particle filter, new fully-charged battery and a standard airflow.
- G Brushless motor:** with an average life three times longer than conventional motors.
- H Filter Indicator:** indicates the status of the particle filter.
- I Airflow Plus:** for hot, humid jobs, you can increase the airflow from 170 l/min to 200 l/min with the push of a button.
- J Breathing tube:** self-adjusting or heavy-duty rubber.
- K Exclusive airflow pattern:** evenly distributes filtered air throughout the entire breathing zone of the helmet. The intelligent turbo unit keeps the airflow rate at a constant, preset level. A diffuser spreads out the airflow pattern for your maximum comfort.
- L Soft, flexible face seal (removed here for clarity):** creates a positive pressure environment within the helmet, keeping the surrounding pollutants at bay.

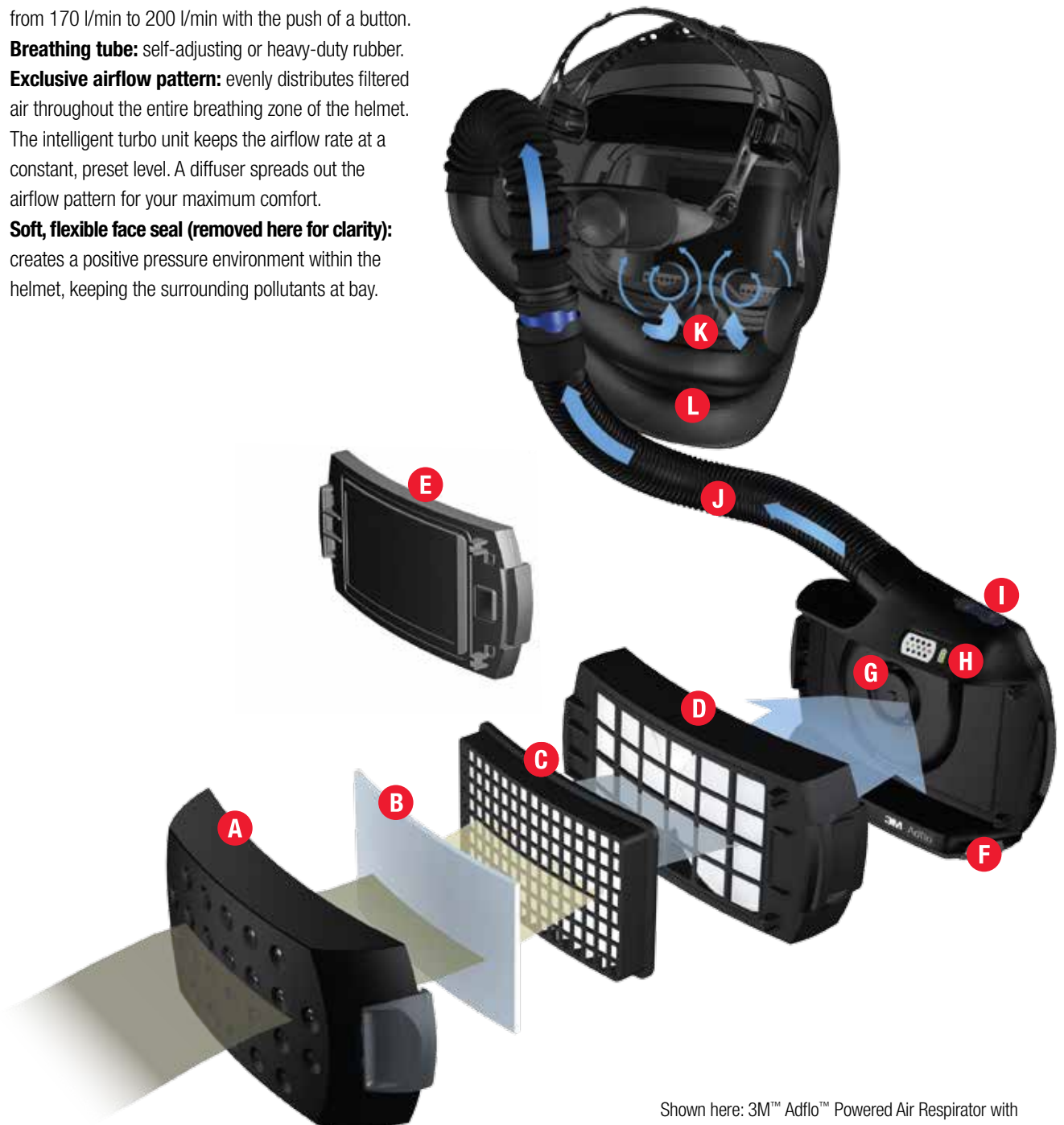

Shown here: 3M™ Adflo™ Powered Air Respirator with 3M™ Speedglas™ Welding Helmet 9100 FX Air.



“It’s Like My Own
Private Oasis”

Complete Respirator Systems



3M™ Speedglas™ Welding Helmet 9100 Air with 3M™ Adflo™ Powered Air Respirator

Ergonomic auto-darkening welding protection with optimal mobility and ease-of-use.

Part no*: — Speedglas welding helmet 9100 Air, variable shade 5, 8, 9–13 and Adflo respirator with particle filter:

- 56 77 05 with Speedglas welding filter 9100V (45 x 93 mm)
- 56 77 15 with Speedglas welding filter 9100X (54 x 107 mm)
- 56 77 25 with Speedglas welding filter 9100XX (73 x 107 mm)



3M™ Speedglas™ Welding Helmet 9100 FX Air with 3M™ Adflo™ Powered Air Respirator

A flip-up combination of an auto-darkening welding helmet and a 17 x 10 cm clear visor for weld preparations. Excellent for low-light conditions and continuous eye, face, TH3-rated respiratory protection.

Part no*: — Speedglas welding helmet 9100 FX Air, variable shade 5, 8, 9–13 and Adflo respirator with particle filter:

- 54 77 05 with Speedglas welding filter 9100V (45 x 93 mm)
- 54 77 15 with Speedglas welding filter 9100X (54 x 107 mm)
- 54 77 25 with Speedglas welding filter 9100XX (73 x 107 mm)



3M™ Speedglas™ Welding & Safety Helmet 9100 MP with 3M™ Adflo™ Powered Air Respirator

Welding and safety helmet with auto-darkening welding filter and a 17 x 10 cm clear visor for weld preparations. Five levels of welder protection: head, eye, face, respiratory and hearing into one comfortable and easy-to-use system.

Part no*: — Speedglas welding and safety helmet 9100 MP, variable shade 5, 8, 9–13 and Adflo respirator with particle filter:

- 57 77 05 with Speedglas welding filter 9100V (45 x 93 mm)
- 57 77 15 with Speedglas welding filter 9100X (54 x 107 mm)
- 57 77 25 with Speedglas welding filter 9100XX (73 x 107 mm)



3M™ Adflo™ High Altitude Powered Air Respirator

For welders working at higher altitudes there is a special respirator version to adjust for changes in air density. Fits with all welding helmets and faceshields shown on this page.

Part no*:

- 83 78 30 Adflo high altitude powered air respirator with particle filter (Headtop and welding filter must be ordered separately)



* For gas protection add any of these part numbers to your order: 83 72 42 for gas filter A1B1E1, or 83 75 42 for gas filter A2. These filters require a breathing tube with silencer (83 40 08) and the heavy-duty battery (83 76 31).

3M™ Versaflo™ Supplied Air Regulator V-500E

Light In Weight, With Higher Airflows

3M™ Versaflo™ Supplied Air Regulator V-500E is a balanced, belt-worn, easy-to-adjust regulator that consistently delivers the airflow level you set — from 170 l/m to 305 l/m. An integrated silencer keeps the noise level equivalent to a typical conversation. The regulator’s warning whistle sounds if there is low airflow from the regulator. Air tools can be connected to a port on the regulator without reducing the airflow to your helmet.

The Versaflo regulator V-500E, combined with the 3M™ Speedglas™ Welding Helmets 9100 FX Air or 9100 MP helmet unique air delivery system achieves a Nominal Protection Factor (NPF) of 200 (NPF 50 with the 3M™ Speedglas™ Welding Helmet 9100 Air*).

* Available end of 2013



Quick Connections

The belt-mounted regulator connects to an approved breathing tube with a quick release connector system. The airline supply must be air of breathable quality meeting the requirement of EN 12021.

Oil mist, water vapour, or non-toxic, unpleasant odours in the air supply can be removed with an air cleaning station, such as the 3M™ Filtration Systems ACU-1 and ACU-2.



Complete Respirator Systems



SOON AVAILABLE

3M™ Speedglas™ Welding Helmet 9100 Air with 3M™ Versaflo™ Regulator V-500E

Welding Helmet with auto-darkening welding filter combined with a supplied air regulator.

Part no: Speedglas welding helmet 9100 Air with Versaflo regulator V-500E:

56 85 05 with Speedglas welding filter 9100V.

56 85 15 with Speedglas welding filter 9100X.

56 85 25 with Speedglas welding filter 9100XX.



3M™ Speedglas™ Welding Helmet 9100 FX Air with 3M™ Versaflo™ Regulator V-500E

Welding helmet with auto-darkening welding filter and a 17 x 10 cm clear visor for weld preparations. Excellent for low-light conditions and continuous eye, face and respiratory protection.

Part no: Speedglas welding helmet 9100 FX Air with Versaflo regulator V-500E:

54 88 05 with Speedglas welding filter 9100V.

54 88 15 with Speedglas welding filter 9100X.

54 88 25 with Speedglas welding filter 9100XX.



3M™ Speedglas™ Welding Helmet 9100 MP with 3M™ Versaflo™ Regulator V-500E

Welding helmet with auto-darkening welding filter and a 17 x 10 cm clear visor for weld preparations. Five levels of welder protection: head, eye, face, respiratory and hearing into one system.

Part no: Speedglas welding helmet 9100 MP with Versaflo regulator V-500E:

57 88 05 with Speedglas welding filter 9100V.

57 88 15 with Speedglas welding filter 9100X.

57 88 25 with Speedglas welding filter 9100XX.

3M™ Versaflo™ Faceshield and Helmet M-Series

Highly Versatile Rigid Headtops

The 3M™ Versaflo™ Headtops M-series feature light-weight, compact and well-balanced faceshields and helmets that can offer integrated protection from a range of respiratory, head, eye and hearing hazards, with offerings for neck and shoulder coverage.

The Versaflo helmet M-307 and faceshield M-107 can be used in combination with 3M™ Adflo™ Powered Air Respirator or 3M™ Versaflo™ Supplied Air Regulator V-500.

Fully-adjustable suspension that includes textile straps for optimal fit and weight distribution.

A deflector allows users to direct the airflow inside the headtop for increased control and comfort.

Accessories include ear-muffs, peel-off's, head covers and a chin strap. Spare parts and accessories are quick and easy to replace; for example, visors easily slide into place and are secured by quickly snapping two buttons.

The visor design combines excellent peripheral and downward vision with good optical clarity. Coated visors provide added chemical and scratch resistance.



To suit a wide range of needs, industries and applications, Versaflo M-Series headtops offer faceseals and shrouds in various fabrics.

Excellent Airflow

3M™ Versaflo™ M-Series Headtops direct a comfortable stream of flowing air to where workers need it most: the head and face. The moving airflow can make hot environments more tolerable while greatly reducing visor fogging.



Complete Respirator Systems



3M™ Versaflo™ Faceshield M-107

Lightweight, compact and well-balanced faceshield that can offer integrated protection from a range of eye, face and hearing hazard. Features a flame resistant faceseal for applications with hot particles.

Part no:

84 77 20 Versaflo faceshield M-107 with 3M™ Adflo™ Powered Air Respirator.*

M-107 Versaflo faceshield M-107 only. (3M™ Versaflo™ Supplied Air Regulator V-500E must be ordered separately, see page 51)



3M™ Versaflo™ Helmet M-307

Features a flame resistant faceseal for applications with hot particles. Head protection approved according to EN 397.

Part no:

85 77 20 Versaflo helmet M-307 with 3M™ Adflo™ Powered Air Respirator.*

M-307 Versaflo helmet M-307 only. (3M™ Versaflo™ Supplied Air Regulator V-500E must be ordered separately, see page 51)



3M™ Protective Visor Shade 5

Eye, face and respiratory protection for bright lighting conditions, for example gas or plasma cutting. Visor in polycarbonate, shade 5.

Part no:

89 77 25 Protective visor shade 5 with 3M™ Adflo™ Powered Air Respirator.*



* Particle filter included. For gas protection add any of these part numbers to your order: 83 72 42 for gas filter A1B1E1, or 83 75 42 for gas filter A2.

These filters require a breathing tube with silencer (83 40 08) and the heavy-duty battery (83 76 21).

Frequently Asked Questions about Welding Fumes

1) Which respirator do I need when welding stainless steel?

When welding stainless steel with MIG or MMAW, the welding fumes often contains particles of chromium and nickel, of which chromium is the more toxic. A powered air respirator with particle filter offers you excellent protection in this application. TIG welding does not usually emit much welding fume but creates large quantities of ozone gas: read more under point 6. Plasma cutting and plasma welding give rise to high temperatures, which can emit damaging oxides of nitrogen: read more under point 7.

2) Do I really need respiratory protection when welding ordinary steel?

Although welding fumes from normal steel is not one of the more hazardous types, it is far from good for your health. Among other things, it contains particles of iron oxide, which can cause siderosis (chronic inflammation of the lungs). When welding with MIG/MAG or stick, there are heavy fume emissions, meaning that both a respirator and good ventilation in the workplace are necessary. When welding ordinary steel, a powered air respirator with particle filter is recommended.

3) What sort of respirator is needed when welding surface-treated material?

When welding surface-treated material, a number of hazardous pollutants can be released. When welding galvanised steel, zinc oxide particles are released. These can cause zinc ague, also known as fume fever. If you weld painted material you should be especially careful, as many paints can give off very hazardous air pollutants. When welding galvanised steel or material painted with lead primer, it is recommended that you use a powered air respirator with a particle filter and an odour filter to minimise unpleasant smells. If the material is painted with two component paint or insulated with polyurethane, you should always contact a Safety Engineer. There is a large risk that you will be exposed to isocyanates, which are very hazardous to inhale and difficult to detect. In these cases it is recommended that a supplied air respirator is used.

4) What respiratory protection do I need in restricted areas?

If you are welding in restricted or semi-ventilated areas — where there is a potential for build up of higher levels of contaminant and/or a reduction in oxygen levels — a supplied



air respirator is suggested, regardless of welding method. With a supplied air respirator, providing breathable quality air, you can be confident of getting sufficient oxygen, as well as high levels of protection against gas and particulate contaminants. Powered or supplied air respirators are never to be used in atmospheres immediately dangerous to life or health (IDLH). Always ask a Safety Engineer if you are unsure!

5) Do shielding gases and alloyed electrodes affect my working environment?

When welding with MIG and TIG, the noble gases argon and helium are used as shielding gases. Neither argon nor helium is considered hazardous, but they can displace oxygen in unventilated areas. In such cases, a supplied air respirator is required. When welding with MAG, carbon dioxide, or a mixture of carbon dioxide and a noble gas, is used as a shielding gas. Since parts of the shielding gas can be converted into carbon monoxide when the gas reaches the air, large quantities of carbon monoxide can form around the welding arc. Carbon monoxide cannot be filtered away. If the ventilation is bad, the oxygen level must be monitored and a supplied air respirator used. Alloyed electrodes are common when welding with MAG. The alloys often contain manganese or silicates. This means that large quantities of manganese oxide and silicates are diffused into the surrounding air when you are welding. A powered air respirator with particle filter usually offers sufficient protection against alloy particles.

6) When does ozone form?

When welding aluminium not only are particles of aluminium oxide produced but ozone gas is formed by the action of the UV radiation from the arc breaking down molecular oxygen. Ozone is also produced when welding stainless steel with TIG. Eventually ozone will be converted back to oxygen, a process that is speeded up when the ozone comes into contact with solid surfaces. Ozone cannot be filtered from the atmosphere but relies on being converted back to oxygen. At low ozone concentrations the use of a powered air respirator with particulate filter reduces the amount of ozone reaching the welder. This is achieved by the fact that the particle filter (because of its large surface area) and the breathing tube to the welding helmet help to catalyse the conversion of ozone back to normal oxygen. At higher concentrations the inclusion of a gas filter would add an additional large surface of carbon granules on which a further reduction of ozone takes place.



7) What are nitrogen gases?

Nitrogen dioxide and nitric oxide are examples of nitrogen gases that are formed when you weld with high amperage and high temperatures. Nitrous gases are formed by a reaction in the air between nitrogen and oxygen and are hazardous to inhale in high concentrations, e.g. when welding in confined, poorly ventilated areas. It is recommended that a supplied air respirator is used in such cases.



































































































A General Guide to Respiratory Protection

3M offers a wide range of personal respiratory protection, providing unequalled comfort and protection in the toughest conditions.

-  Powered air respirator with particle filter, page 24.
-  Powered air respirator with A1B1E1 gas filter, page 24.
-  Supplied air regulator, page 28.

How to use this guide:

Identify the material to be welded and the welding process to be used. The concentration levels of the pollutants are affected by the ventilation conditions in the workplace. Choose the appropriate description of the working environment to determine the most suitable type of respiratory protection.*

Material to be welded	Welding method	Ventilation conditions of your working environment			
		Good environment, with forced ventilation	Limited ventilation	Restricted space	Classified as IDLH
Aluminium	MIG 		 /  + 		Powered and supplied air respirators must never be used in atmospheres Immediately Dangerous to Life or Health (IDLH). Always consult your Safety Engineer.
	TIG 		 /  + 		
	STICK WELDING 		 /  + 		
Stainless steel	MIG 		 /  + 		
	TIG 		 /  + 		
	PLASMA (Welding and Cutting)		 +  / 		
Steel not coated or painted	MIG/MAG 				
	STICK WELDING 				
	PLASMA (Welding and Cutting)		 / 		
Steel painted (lead based paints)	MIG/MAG 				
	STICK WELDING 				
	PLASMA (Welding and Cutting)		 / 		
Steel galvanised	MIG/MAG 				
	STICK WELDING 				
	PLASMA (Welding and Cutting)		 / 		
Steel coated with 2-component paints or insulated with 2-part polyurethanes (risk of isocyanates)	MIG/MAG 				
	STICK WELDING 				
	PLASMA (Welding and Cutting)				
Material cleaned with trichloroethylene	MIG 				
	TIG 				
	STICK WELDING 				
	PLASMA (Welding and Cutting)				

* 3M accepts no liability for the incorrect choice of respiratory protective equipment. This chart is only an outline. It is designed to help focus on the most appropriate respirators in the 3M range for particular applications. It should not be used as the only means of selecting a respirator. Details regarding performance and limitations are set out on the respirator packaging and user instructions.

Respiratory Filter Guide

Code Type of filter

E	Acid gases.
A	Organic gases, boiling point >65 °C.
AX	Organic gases, boiling point <65 °C.
P	Particle filter.
B	Inorganic gases.

Remarks

H =	The chemical can be absorbed through the skin.
K =	The chemical can be cancer-inducing.
S =	The chemical can be a sensitizer.

- Argon and helium are inert gases which are not generally absorbed by canister type filters. These gases are not in themselves hazardous but can displace oxygen from the air when present in confined spaces.
- Ozone is not readily filtered by absorption type filters. However, ozone reverts back to normal oxygen upon contact with solid surfaces. The use of Speedglas Welding Helmet or Protective Visor with Adflo Respirator (particle filtration) will reduce ozone exposure. (For further information please contact 3M Technical Service at your local 3M office.)
- Chemical constituents of a welding fume with very low Occupational Exposure Limits can pose special hazards and are sometimes best protected against by using a Supplied Air Regulator System. If in doubt, always seek professional advice from your Safety Engineer.

Occupational Exposure Limits (OELs) are given in each individual country's national safety requirements.

Get information for the UK on www.hse.gov.uk

Suggested Filter Type				
Chemical	Particle	Gas	Supplied Air	Remarks
Aluminium	P			
Argon			Supplied Air	1
Beryllium	P		Supplied Air	K, S 3
Bromine		B		
Cadmium	P			K
Carbon Dioxide			Supplied Air	
Carbon Monoxide			Supplied Air	
Chlorine		B		H
Chlorine Dioxide		B		
Chromium Hexavalent	P			K
Chromium Trivalent	P			
Copper	P			
Fluorides	P			
Fluorine			Supplied Air	
Helium			Supplied Air	1
Isocyanates			Supplied Air	S
Hydrogen Chloride		B	Supplied Air	3
Hydrogen Cyanide		B	Supplied Air	H3
Hydrogen Fluoride		B	Supplied Air	3
Hydrogen Sulphide		B		
Iron Oxide	P			
Lead	P			
Magnesium	P			
Manganese	P			
Nickel	P			S
Nitrogen Dioxide			Supplied Air	
Nitric Oxide			Supplied Air	
Ozone	P	ABE		2
Phosgene			Supplied Air	3
Phosphine			Supplied Air	
Silicon Dioxide	P			
Sulphur Dioxide		E		
Trichloroethylene		A		K
Vanadium Oxide	P			
White Spirit		A		
Zinc	P			
Zinc Chloride	P			
Zinc Oxide	P			

How ADFs Work



Before:

With the helmet in the safe down position, you have a clear view through the welding filter. Both of your hands are free and the electrode can be precisely positioned.



During:

Within 0,1 milliseconds of the arc strike, the filter has switched to the dark state.



After:

The filter automatically returns to the clear state after welding is complete, allowing your immediate and safe inspection of the weld pool, as well as preparation for the next weld.

Eye protection that increases your performance

The key to remember with 3M™ Speedglas Auto Darkening Welding Filters (or ADFs) is consistency. They enable constant, comfortable vision. They provide constant protection from ultraviolet and infrared (UV/IR) radiation. And they consistently auto-switch from clear to dark, and back again, in just the way you want.

Awkward made easier

Speedglas Welding Filters also eliminate the neck-strain of “helmet flipping,” while greatly increasing the accuracy of electrode placement. This, in turn, reduces the need for grinding and rework. In addition, you can get into tight, cramped spaces with your eye and face protection already in place. The filters’ constant, clear views make even extremely awkward welds a lot easier.

How fast does a 3M™ Speedglas™ Welding Helmet pay for itself?

If profitability is defined in terms of protection, one day is enough. But while “protection” sometimes can be difficult to measure, efficiency and weld quality are much easier to gauge. Studies show that you can increase efficiency substantially when using Speedglas ADFs. Not only can you work faster when you can always see, but you move more efficiently, placing electrodes more precisely.

Most “bad weld starts” can be eliminated. Fewer bad welds mean less grinding and higher overall quality levels.

For example:

Productivity gains are, of course, dependent on the application. If you do lots of tack welds, you will have much greater productivity gains than a welder doing long seam welds. With that said, this example uses a conservative 15% gain in productivity. If cost for salary is € 20 per hour, the welding helmet will pay for itself in two months. In one year, the productivity gain will be € 4500 in savings (also known as new profits).

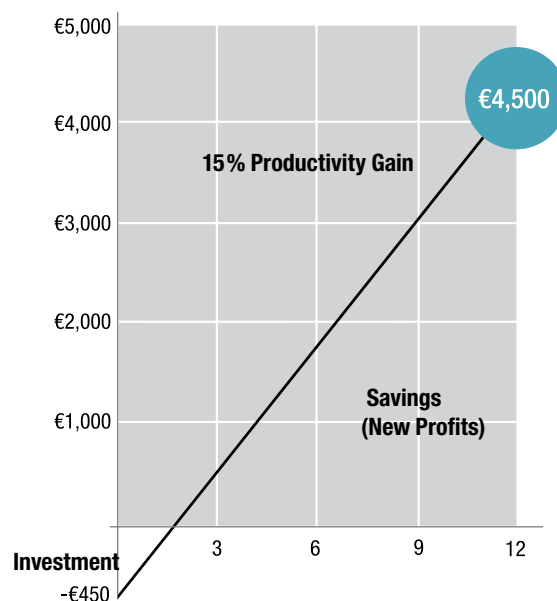

Recommended shade numbers according to EN 379:2003

Welding process	Current in amperes A																								
	1.5	6	10	15	30	40	60	70	100	125	150	175	200	225	250	300	350	400	450	500	600				
MMAW (covered electrodes)	8						9			10			11			12			13			14			
MAG	8								9		10		11			12				13					
TIG				8			9			10			11			12			13						
MIG									9		10		11			12			13			14			
MIG with light alloys											10		11			12			13			14			
Air-arc gouging	10												11		12		13		14		15				
Plasma jet cutting									9		10		11		12			13							
Microplasma arc welding	4		5		6		7		8		9		10		11		12								
	1.5	6	10	15	30	40	60	70	100	125	150	175	200	225	250	300	350	400	450	500	600				

The table recommends best dark shade of welding filter for various working applications. According to the conditions of use, the next greater or the next smaller scale number can be used.

Transmittance (%)

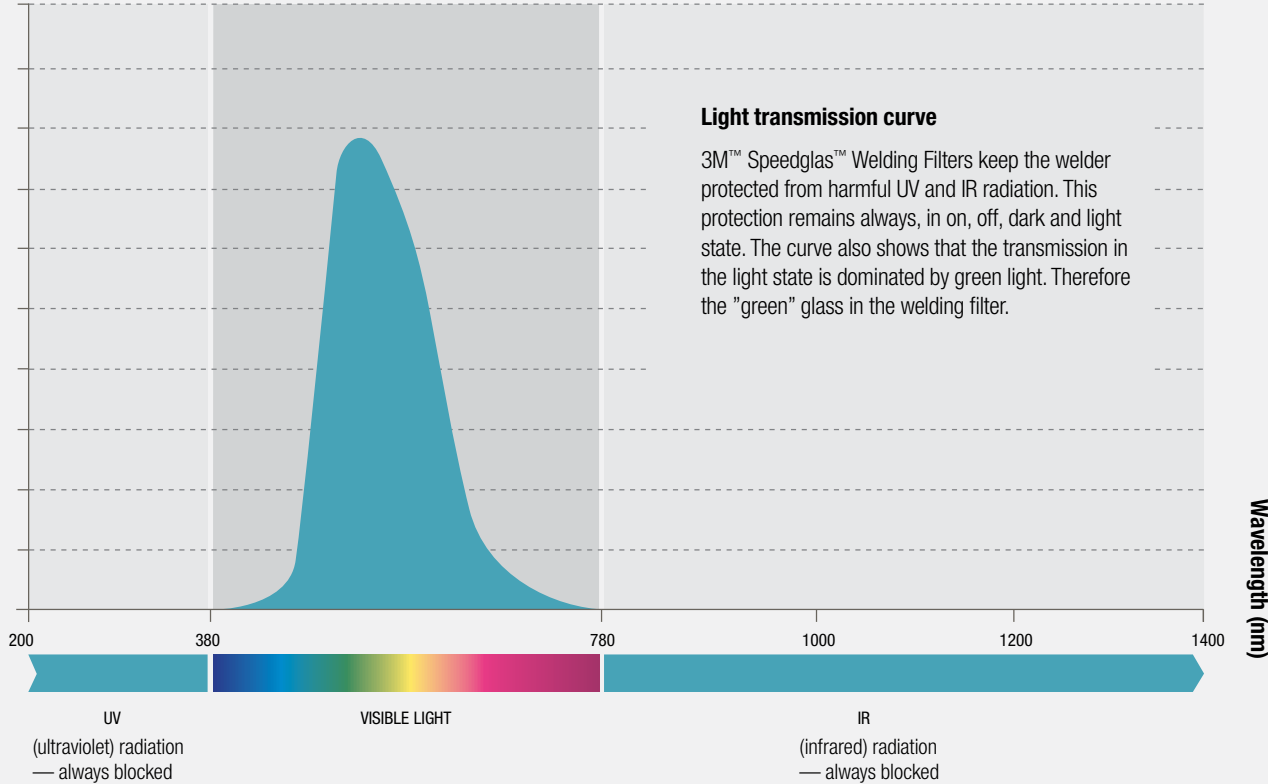

CE Approvals and European Standards

In Europe, all personal protective equipment (PPE) must be CE marked and in compliance with the PPE Directive 89/686/EEC before they can be placed on the market. The PPE must also be in compliance with applicable, national, harmonized standards that ensure that the basic safety requirements in the PPE Directive are met.

European classification of eye and face protection

Welding helmets incorporating protective filters are covered by the standards EN 175, EN 166 and EN 169 (passive filters) or EN 379 (auto-darkening filters). The protective visors are covered by EN 166. In EN 175 and EN 166, the PPE is classified according to its mechanical strength: increased robustness (S) or resistance to high speed particles (F or B).

In EN 166, it is optional to complement the classification for mechanical strength with the letter (T) for extremes of temperatures (-5° C and +55° C). In addition there are classifications regarding field of use: “9” for protection against splashes of molten metals and penetration of hot solids; “3” for protection against liquids (droplets or splashes); and “8” for protection from electric arcs due to a short circuit in electrical equipment. For the standards EN 166 and EN 379, optical quality of the welding filter or faceshield are classified from 1 to 3, where 1 is the best. For passive welding filters and visors, there is only one classification of optical class. For auto-darkening welding filters, there are four parts of the classification: optical class/diffusion of light/variability in luminous transmittance/angle dependence.

Grinding and mechanical strength

The mechanical strength of all 3M™ Speedglas™ Welding Helmet Series 9100 are approved to EN 175 class “B,” while 3M™ Speedglas™ Welding Helmet 9000 with SideWindows is approved to EN 175 class “F.” Therefore, if you need the SideWindows option and you use your Speedglas helmet for grinding, 3M strongly recommends the choice



Classification of mechanical strength

Class S	Increased robustness (drop ball test 5,1 m/s).
Class F	Resistance to high speed particles at low energy impact (45 m/s).
Class B	Resistance to high speed particles at medium energy impact (120 m/s).
Class T	The letter “T” indicates that the test for resistance to high speed particle was conducted at extremes of temperature (-5° and +55°C) (optional).

Note: Products classified in class B are not made to give total protection under all possible circumstances, e.g. when using grinding wheels/grinding machines.

of Speedglas 9100 or Speedglas 9100 FX welding helmets with SideWindows over the older Speedglas 9000 models with SideWindows. You can find the classification for our products in the technical data table on page 60. For more details on European Standards, or to purchase European Standards, contact your National Standards Institute

European standards for powered air respirators

The European standard for a complete powered air filtering device incorporating a face helmet or visor is EN 12941. There is no separate classification for particle filters (P) in the standard EN 12941 as the particle filter is part of the system classification. Standard EN 12941 defines three classes of performance (TH1, TH2 and TH3). The numbers define the level of performance (inward leakage) and the pull strength of the breathing tubes and couplings within the classification. Inward leakage for classification TH1 is maximum 10%, for TH2 maximum 2% and for TH3 maximum 0.2%.

Gas filters have letters and colour codes that indicate which gases the filter provides protection against, as defined by the standard EN 12941. For example: “A” for organic, “B” for inorganic, and “E” for acid gases. For powered air filtering respirators, the capacity of a gas filter is determined by testing the unit at its airflow rate. The gas filter’s numbers indicate its capacity: “1” for low capacity, “2” for medium capacity, or “3” for high capacity. For example, one of the gas filters available for the 3M™ Adflo™ Respirator is classified as A1B1E1.



European standards for supplied air respirators

Respiratory protection devices with compressed air line breathing apparatus is in scope of EN 14594*. The apparatus is not self-contained and the airline supply must be air of breathable quality meeting the requirements in EN 12021.

* EN 270 has been replaced by EN 14594 and new systems will be approved to EN 14954.

3M™ Speedglas™ Welding Helmets (non-respiratory models)

Speedglas™ Welding Helmet 9100	42
Speedglas™ Welding Helmet 9100 FX	43
Speedglas™ Welding Helmet Series 100	45
Speedglas™ Welding Helmet SL	46
Speedglas™ Welding Helmet 9000 FlexView	46
Speedglas™ Welding Helmet 9000	47
Safety helmet options for Speedglas™ Welding Helmets	48

3M™ Respiratory Protection

Adflo™ Powered Air Respirator	50
Versaflo™ Supplied Air Regulator V-500E	51
Spare parts for Fresh-air™ Supplied Air Regulator	51
3M™ Supplied Air Filtration Units	52

3M™ Headtops for Respiratory Protection

Speedglas™ Welding Helmet 9100 Air	53
Speedglas™ Welding Helmet 9100 FX Air	54
Speedglas™ Welding & Safety Helmet 9100 MP	55
Versaflo™ Headtops M-series	56
Speedglas™ Protective Visors	57
Speedglas™ Welding Filter Adaptor 9100 for passive lens	58
Speedglas™ Welding Helmet Series 9000	59
3M™ Welding Helmet Series 600	60

Care and Maintenance	62
Technical Specifications	63
Product Index	66



3M™ Speedglas™ Welding Helmets and Filters

— Product Overview

The Speedglas auto-darkening welding filter was one of the first of its type on the market, bringing a new standard to eye protection and comfort for welders.

Today, there is a great family of Speedglas welding helmets, each model with its specific series of welding filters:

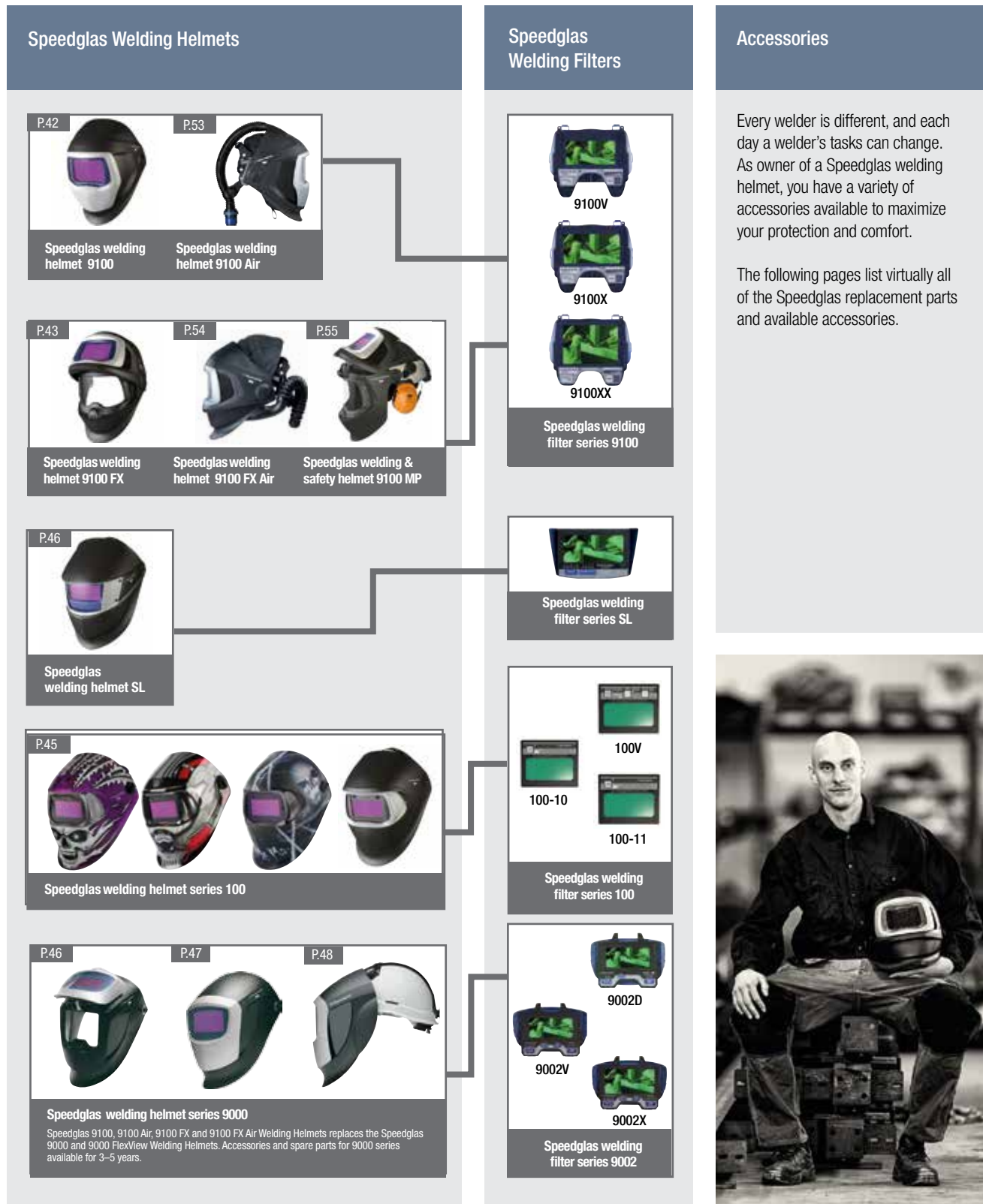

3M™ Speedglas™ Welding Helmet 9100



Part No	Description	Part No	Description	Part No	Description
50 11 05	Speedglas welding helmet 9100 without SideWindows, with filter 9100V.	50 11 25	Speedglas welding helmet 9100 without SideWindows, with filter 9100XX.	50 18 15	Speedglas welding helmet 9100 with SideWindows and filter 9100X.
50 11 15	Speedglas welding helmet 9100 without SideWindows, with filter 9100X.	50 18 05	Speedglas welding helmet 9100 with SideWindows and filter 9100V.	50 18 25	Speedglas welding helmet 9100 with SideWindows and filter 9100XX.

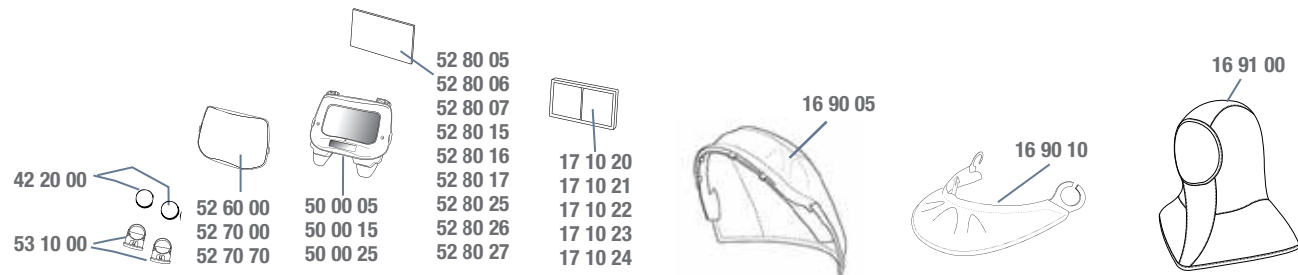
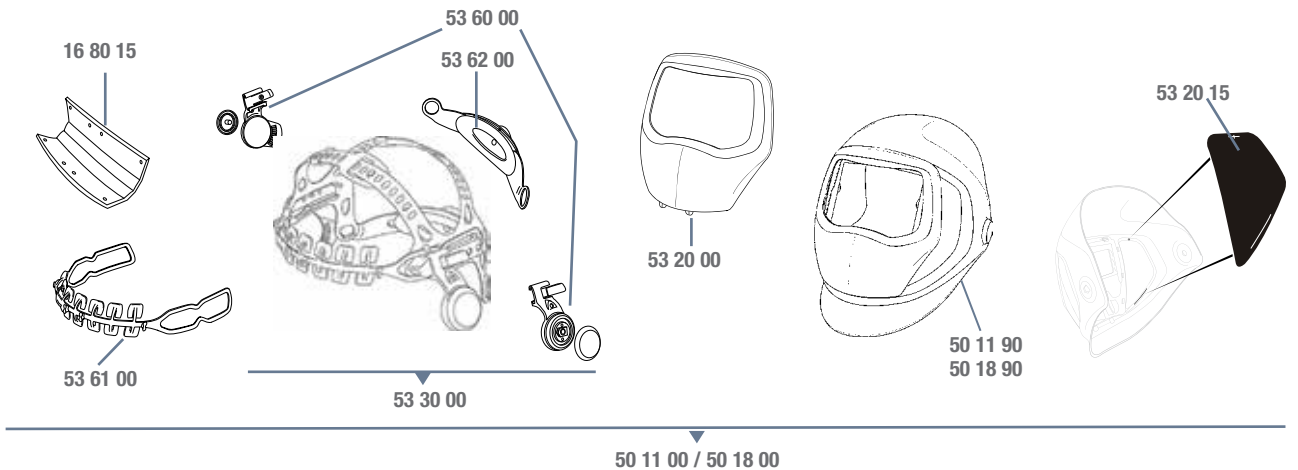

Accessories and spare parts

Part No	Description	Part No	Description	Part No	Description
16 80 15	Comfort sweatband, pkg of 3.	50 18 00	Welding helmet with SideWindows and headband.	52 80 17	Inner cover plate, +2 shade for 9100X filter, pkg of 3.
16 90 05	Head protection, black.	50 18 90*	Welding helmet with SideWindows, without headband.	52 80 25	Inner cover plate for 9100XX filter, pkg of 5. Plate marking 117x77.
16 90 10	Neck protection, black.	52 60 00	Outer protection plate standard, pkg of 10.	52 80 26	Inner cover plate, +1 shade for 9100XX filter, pkg of 3.
16 91 00	Hood, black/grey.	52 70 00	Outer protection plate extra scratch resistant, pkg of 10.	52 80 27	Inner cover plate, +2 shade for 9100XX filter, pkg of 3.
17 10 20	Magnifying lens 1.0.	52 70 70	Outer protection plate heat resistant, pkg of 10.	53 10 00	Battery holder, pkg of 2.
17 10 21	Magnifying lens 1.5.	52 80 05	Inner cover plate for 9100V filter, pkg of 5. Plate marking 117x50.	53 20 00	Heat-reflecting silver front.
17 10 22	Magnifying lens 2.0.	52 80 06	Inner cover plate, +1 shade for 9100V filters, pkg of 3.	53 20 15*	SideWindows cover plate, 2 pairs.
17 10 23	Magnifying lens 2.5.	52 80 07	Inner cover plate, +2 shade for 9100V filters, pkg of 3.	53 30 00	Speedglas 9100 headband with assembly parts.
17 10 24	Magnifying lens 3.0.	52 80 15	Inner cover plate for 9100X filter, pkg of 5. Plate marking 117x61.	53 60 00	Pivot mechanism, left and right.
42 20 00	Battery, pkg of 2.	52 80 16	Inner cover plate, +1 shade for 9100X filter, pkg of 3.	53 61 00	Headband front part.
50 00 05	Speedglas welding filter 9100V, variable shade 5, 8, 9–13.			53 62 00	Headband back part.
50 00 15	Speedglas welding filter 9100X, variable shade 5, 8, 9–13.				
50 00 25	Speedglas welding filter 9100XX, variable shade 5, 8, 9–13.				
50 11 00	Welding helmet without SideWindows, with headband.				
50 11 90	Welding helmet without SideWindows, without headband.				

* Please use Part No 50 18 90 when ordering replacement SideWindows.

3M™ Speedglas™ Welding Helmet 9100 FX



Part No	Description	Part No	Description	Part No	Description
54 18 05	Speedglas welding helmet 9100 FX with SideWindows and filter 9100V.	54 18 15	Speedglas welding helmet 9100 FX with SideWindows and filter 9100X.	54 18 25	Speedglas welding helmet 9100 FX with SideWindows and filter 9100XX.

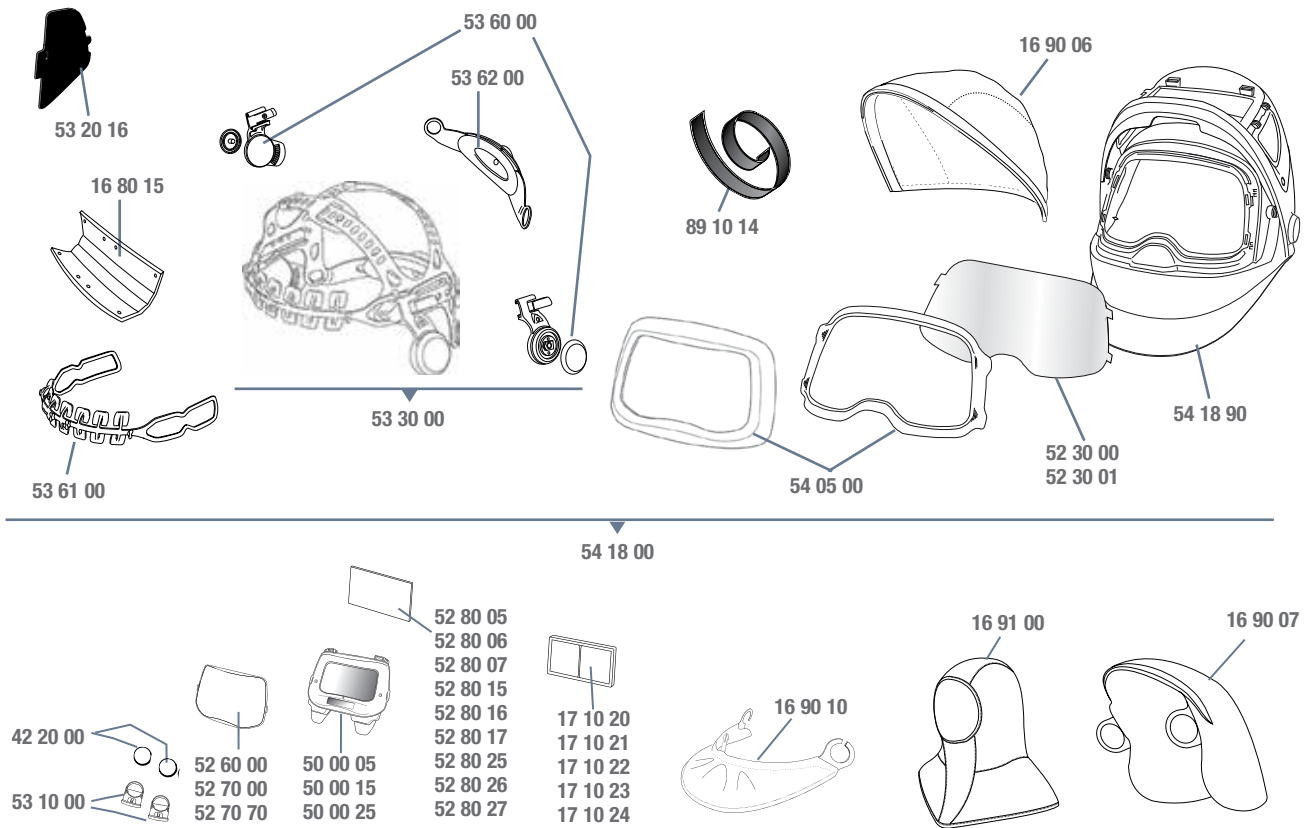

Accessories and spare parts

Part No	Description	Part No	Description	Part No	Description
16 80 15	Comfort sweatband, pkg of 3.	52 70 00	Outer protection plate, extra scratch resistant, pkg of 10.	52 80 27	Inner cover plate, +2 shade for 9100XX filter, pkg of 3.
16 90 06	Head protection (small).	52 70 70	Outer protection plate, heat resistant pkg of 10.	53 10 00	Battery holder, pkg of 2.
16 90 07	Head protection (large).	52 80 05	Inner cover plate for 9100V filter, pkg of 5. Plate marking 117x50.	53 20 16	SideWindows cover plate, 2 pairs.
16 90 10	Neck protection, black.	52 80 06	Inner cover plate, +1 shade for 9100V filters, pkg of 3.	53 30 00	Speedglas headband 9100, with assembly parts.
16 91 00	Hood, black/grey.	52 80 07	Inner cover plate, +2 shade for 9100V filters, pkg of 3.	53 60 00	Pivot mechanism, left and right.
17 10 20	Magnifying lens 1.0.	52 80 15	Inner cover plate for 9100X filter, pkg of 5. Plate marking 117x61.	53 61 00	Headband front part.
17 10 21	Magnifying lens 1.5.	52 80 16	Inner cover plate, +1 shade for 9100X filter, pkg of 3.	53 62 00	Headband back part.
17 10 22	Magnifying lens 2.0.	52 80 17	Inner cover plate, +2 shade for 9100X filter, pkg of 3.	54 05 00	Front cover kit.
17 10 23	Magnifying lens 2.5.	52 80 25	Inner cover plate for 9100XX filter, pkg of 5. Plate marking 117x77.	54 18 00	Welding helmet, without welding filter, with headband.
17 10 24	Magnifying lens 3.0.	52 80 26	Inner cover plate, +1 shade for 9100XX filter, pkg of 3.	54 18 90	Welding helmet, without welding filter, without headband.
42 20 00	Battery, pkg of 2.	52 80 27	Inner cover plate, +2 shade for 9100XX filter, pkg of 3.	89 10 14	Velcro for Headcover, pkg of 2.
50 00 05	Speedglas welding filter 9100V, variable shade 5, 8, 9-13.				
50 00 15	Speedglas welding filter 9100X, variable shade 5, 8, 9-13.				
50 00 25	Speedglas welding filter 9100XX, variable shade 5, 8, 9-13.				
52 30 00	Visor plate standard, pkg of 5.				
52 30 01	Visor plate anti-fog, pkg of 5.				
52 60 00	Outer protection plate, standard, pkg of 10.				

Featured Accessories

Every welder is different, and each day your tasks can change. As the owner of a 3M™ Speedglas™ Welding Helmet, you have a variety of accessories available to maximize your protection and comfort.

Plus, we now offer a new generation of additional coverage products made in flame-retardant textiles for protection against molten metal, sparks and flames:



Ordering Information for Additional Coverage	3M™ Speedglas™ Welding Helmet Series 100/9000	3M™ Speedglas™ Welding Helmet SL	3M™ Speedglas™ Welding Helmets 9100/9100 Air	3M™ Speedglas™ Welding Helmets 9100FX / 9100FX Air	3M™ Speedglas™ Welding Helmet 9100 MP
Head protection	Part No 16 40 09		Part No 16 90 05	Part No 16 90 07 (large) Part No 16 90 06 (small)	Part No 16 90 13 Safety helmet cover (reflective)
Colour	Black/Grey		Black	Black	
Neck protection	Part No 16 90 01 Black/Grey		Part No 16 90 10 Black		Part No 16 90 01 Black/Grey
Neck protection Colour					
Hood	Part No 16 91 00 Black/grey				
Colour					
Welding cap	Part No 95 44 10 Black Cotton				
Colour					
Material					

3M™ Speedglas™ Welding Helmet Series 100



75 25 20

Part No	Description	Part No	Description	Part No	Description
75 11 01	Speedglas welding helmet 100 Black, including passive filter shade 11	75 17 20	Speedglas welding helmet 100 Aces High with 100V filter.	75 24 20	Speedglas welding helmet 100 Razor Dragon with 100V filter.
75 11 10	Speedglas welding helmet 100 Black with 100S-10 filter.	75 18 20	Speedglas welding helmet 100 Steel Rose with 100V filter.	75 25 20	Speedglas welding helmet 100 Ice Hot with 100V filter.
75 11 11	Speedglas welding helmet 100 Black with 100S-11 filter.	75 19 20	Speedglas welding helmet 100 Skull Jewels with 100V filter.	75 26 20	Speedglas welding helmet 100 Raging Skull with 100V filter.
75 11 20	Speedglas welding helmet 100 Black with 100V filter.	75 20 20	Speedglas welding helmet 100 Wild 'n' Pink with 100V filter.	75 27 20	Speedglas welding helmet 100 Future Combatant with 100V filter.
75 12 20	Speedglas welding helmet 100 Blaze, with 100V filter.	75 21 20	Speedglas welding helmet 100 Steel Eyes with 100V filter.		
75 16 20	Speedglas welding helmet 100 Trojan Warrior with 100V filter.	75 22 20	Speedglas welding helmet 100 Xterminator with 100V filter.		

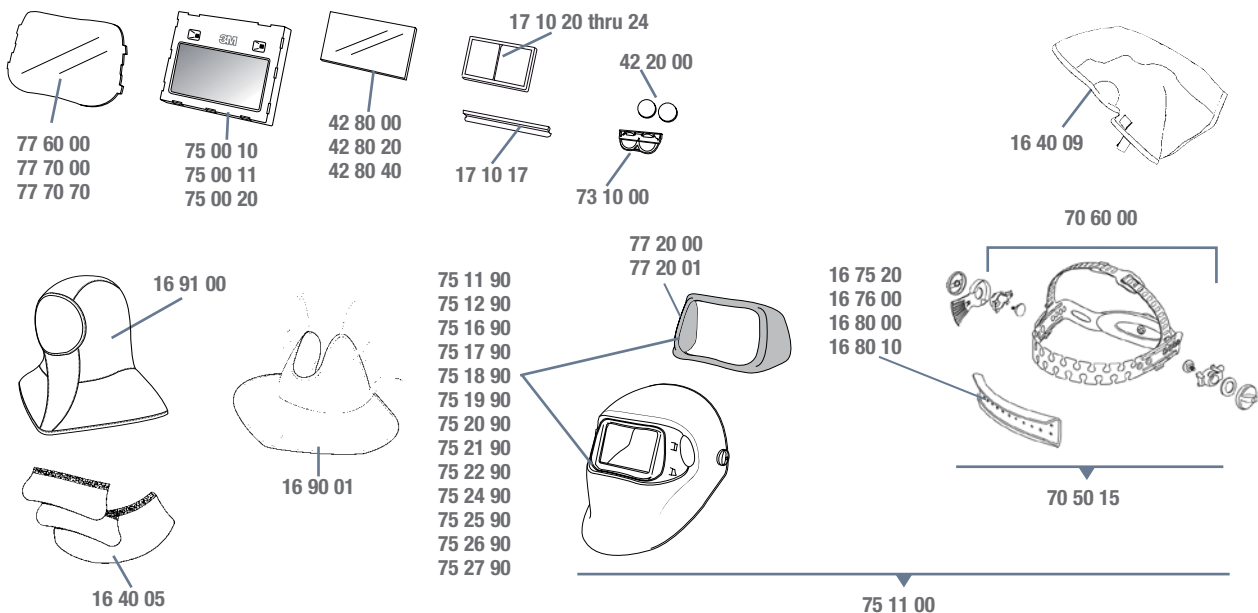

Accessories and spare parts

Part No	Description	Part No	Description	Part No	Description
16 40 05	Ear and neck protection in leather.	75 00 11	Speedglas welding filter 100S-11, single shade 11.	75 21 90	100 welding helmet Steel Eyes, without welding filter, without headband.
16 40 09	Head protection, black/grey.	75 00 20	Speedglas welding filter 100V, variable shade 8-12.	75 22 90	100 welding helmet Xterminator, without welding filter, without headband.
16 75 20	Sweatband, towelling purple, pkg of 2.	75 05 11	Speedglas 100 passive kit: 110x90 mm passive welding filter shade 11, inner cover plate, outer protection plate and filter frame (not shown).	75 24 90	100 welding helmet Razor Dragon, without welding filter, without headband.
16 76 00	Sweatband, towelling purple, pkg of 2.			75 25 90	100 welding helmet Ice Hot, without welding filter, without headband.
16 80 00	Sweatband, leather.			75 26 90	100 welding helmet Raging Skull, without welding filter, without headband.
16 80 10	Sweatband, fleecy cotton.	75 11 00	100 welding helmet black, without welding filter with headband.	75 27 90	100 welding helmet Future Combatant, without welding filter, without headband.
16 90 01	Neck protection, black/grey.	75 11 90	100 welding helmet black, without welding filter, without headband.	77 20 00	Front frame, silver.
16 91 00	Hood black/grey	75 12 90	100 welding helmet Blaze, without welding filter, without headband.	77 20 01	Front frame, black.
17 10 17	Holder for magnifier.	75 16 90	100 welding helmet Trojan Warrior, without welding filter, without headband.	77 60 00	Outer protection plate, standard, pkg of 10.
17 10 20	Magnifying lens 1.0.	75 17 90	100 welding helmet Aces High, without welding filter, without headband.	77 70 00	Outer protection plate, scratch resistant, pkg of 10.
17 10 21	Magnifying lens 1.5.	75 18 90	100 welding helmet Steel Rose, without welding filter, without headband.	77 70 70	Outer protection plate, heat resistant, pkg of 10.
17 10 22	Magnifying lens 2.0.	75 19 90	100 welding helmet Skull Jewels, without welding filter, without headband.		
17 10 23	Magnifying lens 2.5.	75 20 90	100 welding helmet Wild n' Pink, without welding filter, without headband.		
17 10 24	Magnifying lens 3.0.				
42 20 00	Battery, pkg of 2.				
42 80 00	Inner cover plate, pkg of 5. Plate marking 42 02 00.				
42 80 20	Inner cover plate, +1 shade, pkg of 5.				
42 80 40	Inner cover plate, +2 shade, pkg of 5.				
70 50 15	New headband (Sept 2012) with assembly parts.				
70 60 00	Assembly parts for headband.				
73 10 00	Battery cover.				
75 00 10	Speedglas welding filter 100S-10, single shade 10.				

3M™ Speedglas™ Welding Helmet SL



70 11 20

Part No	Description	Part No	Description	Part No	Description
16 40 05	Ear and neck protection in leather (3 parts).	17 10 23	Magnifying lens 2.5.	70 50 15	New headband (Sept 2012) with assembly parts.
16 75 20	Sweatband, towelling, purple, pkg of 2.	17 10 24	Magnifying lens 3.0.	70 60 00	Assembly parts for headband.
16 76 00	Sweatband, towelling, pkg of 20.	17 10 31	Holder for magnifier.	70 62 02	Filter locking frame, pkg of 2.
16 80 00	Sweatband, leather.	42 20 00	Battery, pkg of 2.	72 60 00	Outer protection plate, standard, pkg of 5. Plate marking 030226.
16 80 10	Sweatband, fleecy cotton.	42 80 00	Inner cover plate (42 x 91 mm), pkg of 5. Plate marking 42 02 00.	72 70 00	Outer protection plate, scratch resistant, pkg of 5. Plate marking 030248.
16 90 01	Neck protection black/grey.	42 80 05	42 80 00, pkg Of 200.	73 10 00	Battery cover.
16 91 00	Hood black/grey.	70 00 20	Speedglas welding filter SL, variable shade 8-12.		
17 10 20	Magnifying lens 1.0.	70 11 20	Speedglas welding helmet SL, with welding filter, variable shade 8-12.		
17 10 21	Magnifying lens 1.5.	70 11 90	Welding helmet, without headband.		
17 10 22	Magnifying lens 2.0.				

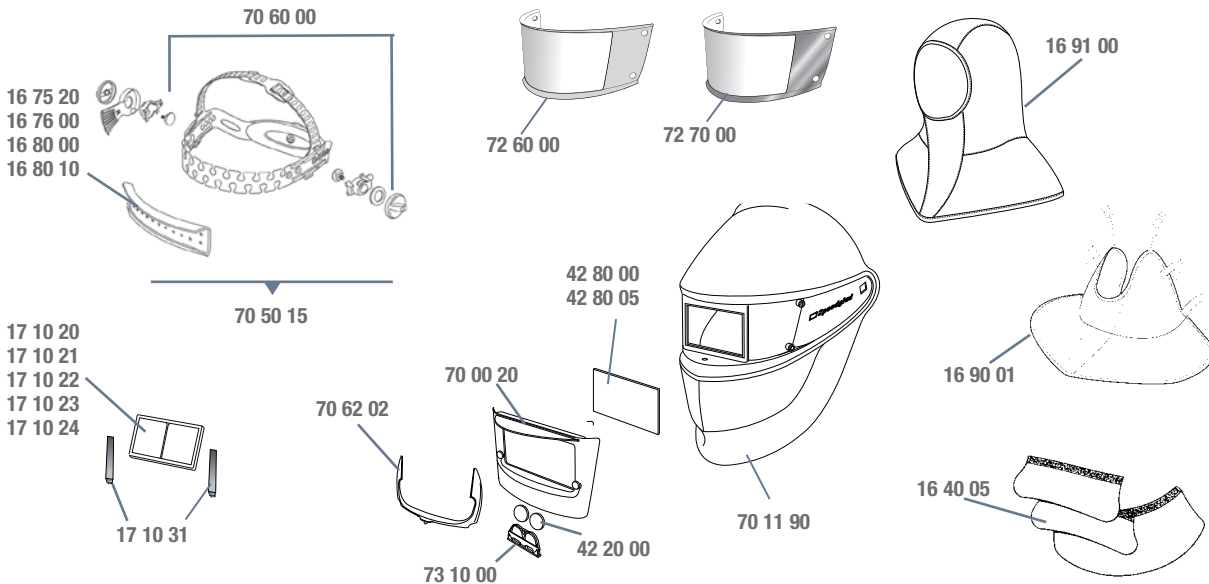

3M™ Speedglas™ Welding Helmet 9000 FlexView



Spare parts**

Part No	Description	Part No	Description
19 71 40	Holder for welding filter.	42 30 00	Protective visor plate, pkg of 10.
19 71 41	Locking wedge kit (holder welding filter).	44 05 00	Speedglas FlexView Conversion Kit.
40 18 90	Speedglas welding helmet 9000 with SideWindows, without headband, without filter.	44 10 00	Middle helmet, black.
		44 20 00	Heatreflecting front, silver.

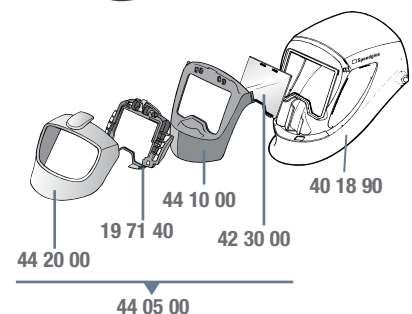

3M™ Speedglas™ Welding Helmets 9000 / Utility



40 11 40
40 18 40

Accessories and spare parts**

Part No	Description	Part No	Description	Part No	Description
16 40 05	Ear and neck protection in leather.	40 11 90	Speedglas welding helmet 9000, without SideWindows, without headband, without filter.	42 80 10	Inner cover plate (53x103 mm) for 9002X/9000XF filters, pkg of 5. Plate marking 42 02 10.
16 40 09	Head protection, black/grey.	40 18 40	Speedglas welding helmet with SideWindows, with filter 9002D, dual shade 9/11.	42 80 20	Inner cover plate, +1 Shade for 9002D/9002V filters, pkg of 5.
16 75 20	Sweatband towelling, pkg of 2.	40 18 90*	Speedglas welding helmet 9000 with SideWindows, without headband, without filter.	42 80 30	Inner cover plate, +1 Shade for 9002X/9000XF filters, pkg of 5.
16 76 00	Sweatband towelling, pkg of 20.	42 20 00	Battery, pkg of 2.	42 80 40	Inner cover plate, +2 Shade for 9002D/9002V filters, pkg of 5.
16 80 00	Sweatband, leather.	42 60 00	Outer protection plate, standard, pkg of 10. Plate marking 42 01 50.	42 80 50	Inner cover plate, +2 Shade for 9002X/9000XF filters, pkg of 5.
16 80 10	Sweatband, fleecy cotton, pkg of 2.	42 70 00	Outer protection plate, scratch resistant, pkg of 10. Plate marking 42 01 00.	43 10 00	Battery cover, pkg of 2.
16 90 01	Neck protection, black/grey.	42 70 71	Outer protection plate, heat resistant, pkg of 10. Plate marking 42 01 71 HEAT.	43 20 00	Heat-reflecting front, silver.
16 91 00	Hood black/grey.	42 80 00	Inner cover plate (42x91 mm) for 9002D/9002V filters, pkg of 5. Plate marking 42 02 00.	43 20 15*	SideWindows cover plate (sticker), 5 pairs.
17 10 15	Holder for magnifying lens (not shown)			70 50 15	New headband (Sept 2012) with assembly parts.
17 10 20	Magnifying lens 1.0.			70 60 00	Assembly parts for headband.
17 10 21	Magnifying lens 1.5.				
17 10 22	Magnifying lens 2.0.				
17 10 23	Magnifying lens 2.5.				
17 10 24	Magnifying lens 3.0.				
40 00 40	Speedglas welding filter 9002D				
40 00 70	Speedglas welding filter 9002V				
40 00 80	Speedglas welding filter 9002X				
40 11 40	Speedglas welding helmet 9000, without SideWindows, with filter 9002D and headband.				

* Please use Part No 40 18 90 when new SideWindows are required.

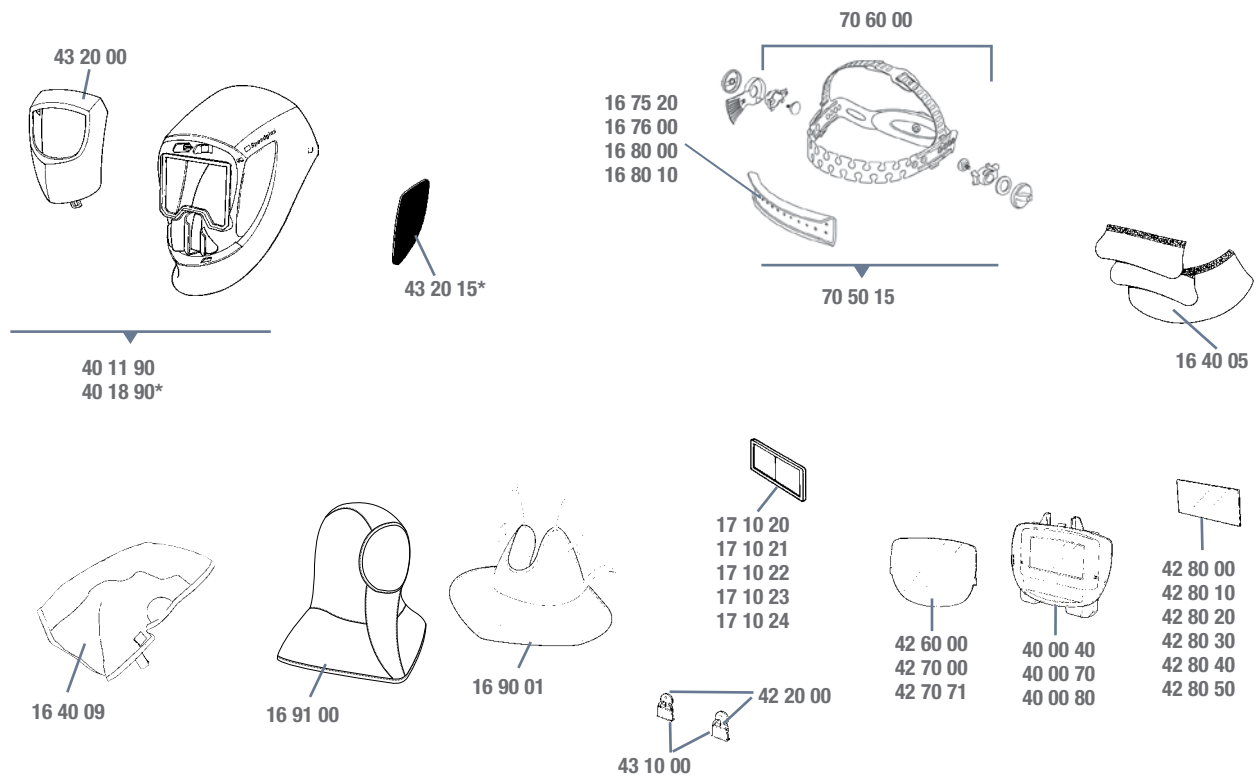

** Speedglas welding helmets 9100, 9100 Air, 9100 FX and 9100 FX Air replaces the welding helmets 9000 and 9000 FlexView. Accessories and spare parts will remain for 3–5 years.

3M™ Speedglas™ Welding Helmet ProTop



48 38 70
48 38 80

Part No	Description	Part No	Description	Part No	Description
16 75 50	Sweatband, pkg of 2.	48 31 00	Speedglas welding helmet ProTop without SideWindows, without welding filter.	48 38 80	Speedglas welding helmet ProTop with SideWindows and 9002X filter.
19 67 05	Safety helmet, white.	48 38 00	Speedglas welding helmet ProTop with SideWindows, without welding filter.		
19 71 30	Safety helmet assembly parts.	48 38 70	Speedglas welding helmet ProTop with SideWindows and 9002V filter.		
19 71 31	Welding helmet mechanism parts.				
48 28 00	Speedglas welding helmet ProTop, with SideWindows, without safety helmet, without welding filter.				

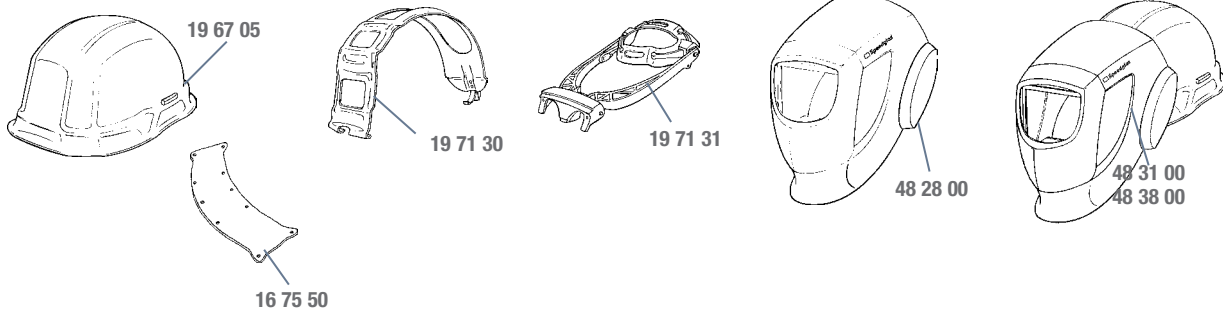

Safety Helmet Options for 3M™ Speedglas™ Welding Helmets 9100 / 9100FX / 100



Part No	Description	Part No	Description	Part No	Description
19 71 35	Safety helmet adapter for Speedglas welding helmet 9100, with assembly parts.	54 38 15	Speedglas welding helmet 9100 FX with 3M safety helmet G3001, with welding filter 9100X.	58 38 25	Speedglas welding helmet 9100 with 3M safety helmet G3001, with welding filter 9100XX.
19 71 36	Safety helmet adapter for Speedglas welding helmet 9100 FX, with assembly parts.	54 38 25	Speedglas welding helmet 9100 FX with 3M safety helmet G3001, with welding filter 9100XX.	78 31 20	Speedglas welding helmet 100 with 3M safety helmet G3001, with welding filter 100V.
19 71 37	Safety helmet adapter for Speedglas welding helmet 100, with assembly parts.	58 38 05	Speedglas welding helmet 9100 with 3M safety helmet G3001, with welding filter 9100V.	G3001NUV-VI	3M safety helmet G3001
54 38 05	Speedglas welding helmet 9100 FX with 3M safety helmet G3001, with welding filter 9100V.	58 38 15	Speedglas welding helmet 9100 with 3M safety helmet G3001, with welding filter 9100X.		

Compatibility of 3M™ Air Delivery Units and Headtops

The new welding helmets and faceshields from 3M feature the QRS type of breathing tube (Quick Release Swivel), which enables one-handed connection and release. Old type of breathing tubes (non QRS) can be used by adding the helmet breathing tube adapter (part no 53 35 05).

The new type of QRS breathing tubes are also approved for 3M™ Speedglas™ Welding Helmet Series 9000 and 3M™ Speedglas™ Protective Visors by adding a specific helmet breathing tube adapter (part no 53 35 06).

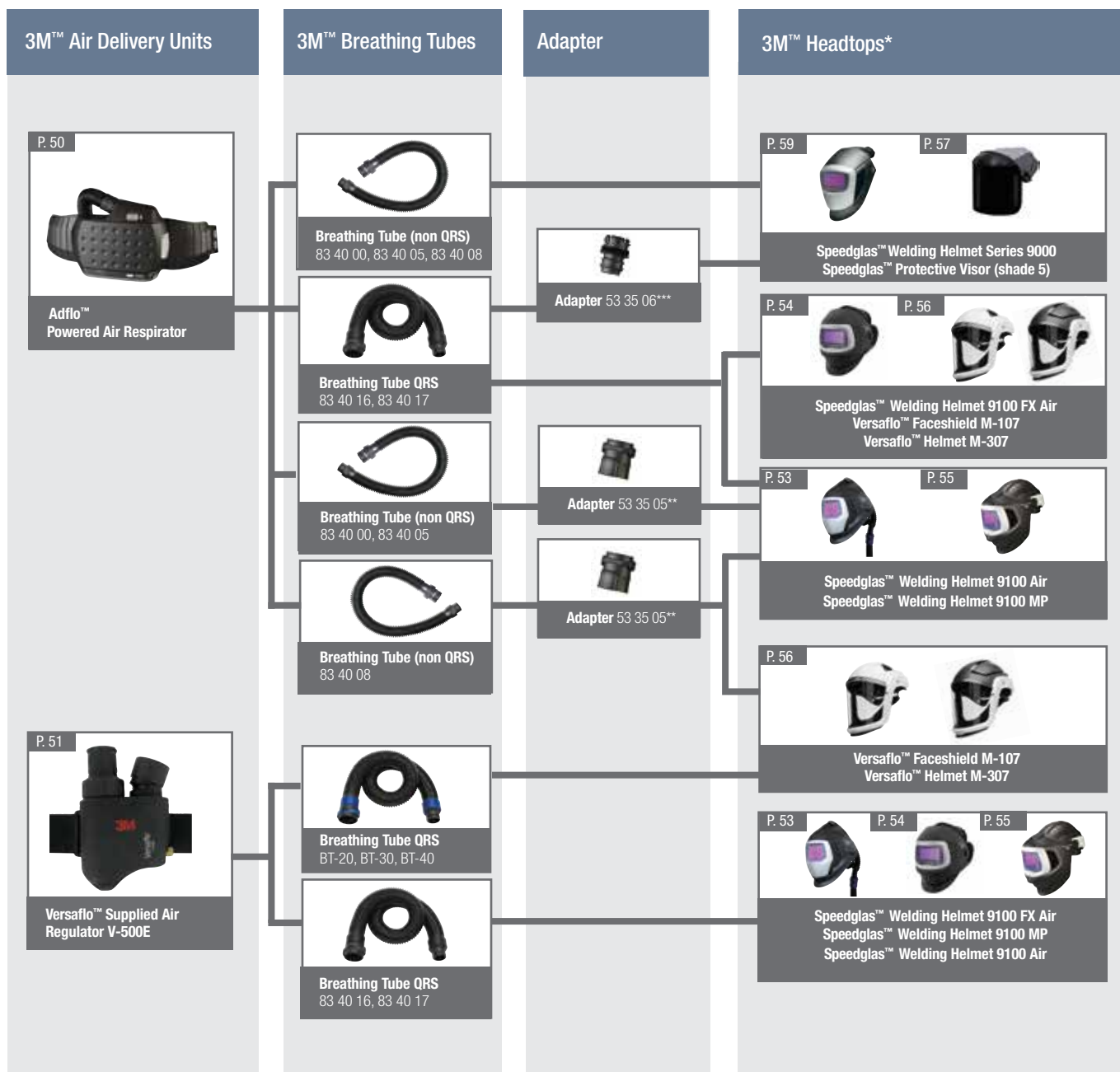

* The Speedglas welding helmet series 9100 replaces most of the Speedglas welding helmet series 9000. Accessories and spare parts for the 9000 helmets will be available for 3-5 years.

** The protection class of Speedglas welding helmet 9100 FX Air is reduced to TH2 when the adapter (53 35 05) is used.

*** When you buy a new complete respirator or regulator with the new breathing tube QRS, it includes the adapter 53 35 06, needed for connecting the Speedglas welding helmet series 9000 and Speedglas visors to the new type of breathing tube.

3M™ Adflo™ Powered Air Respirator



Part No	Description	Part No	Description	Part No	Description
83 77 10	Adflo respirator with self-adjusting breathing tube QRS, adapter (53 35 06), airflow indicator, prefilter, spark arrester, particle filter and battery.	83 77 31	Adflo respirator as in 83 77 30, but with heavy-duty battery.	83 78 30	Adflo High Altitude respirator with self-adjusting breathing tube QRS, breathing tube adapter, airflow indicator, prefilter, spark arrester, particle filter, battery, belt and charger.
83 77 30	Adflo respirator with self-adjusting breathing tube QRS, breathing tube adapter, airflow indicator, prefilter, spark arrester, particle filter, battery, belt and charger.	83 78 10	Adflo High Altitude respirator with self-adjusting breathing tube QRS, adapter (53 35 06), airflow indicator, prefilter, spark arrester, particle filter and battery.	83 78 31	High Altitude Adflo respirator as in 83 78 30 but with heavy-duty battery.

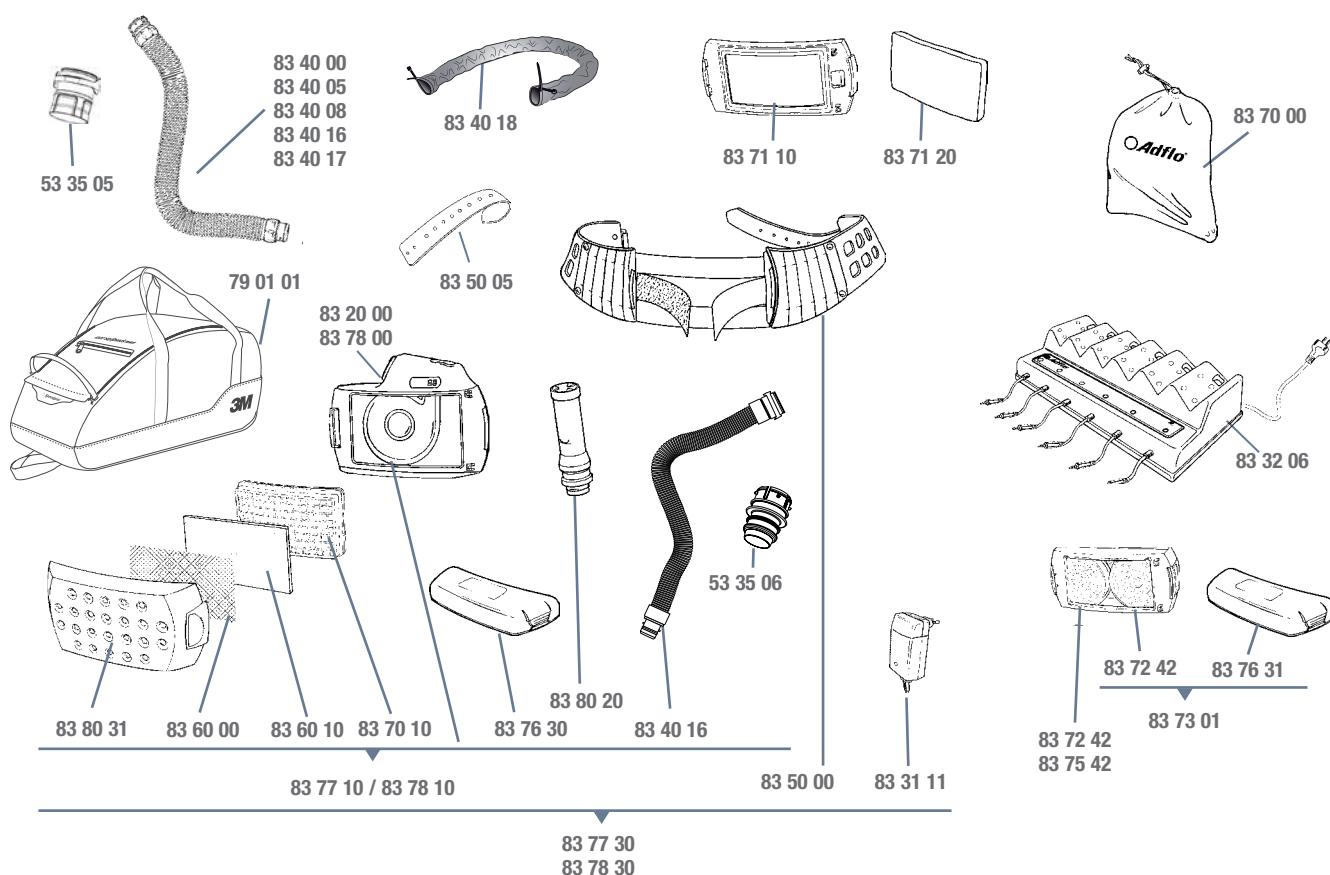

Accessories and spare parts

Part No	Description	Part No	Description	Part No	Description
53 35 05	Adapter for non-QRS breathing tubes when using Speedglas welding helmet series 9100.	83 40 16	Breathing tube, self-adjusting (52,5 to 85 cm), with QRS connection.	83 70 20	Particle filter P SL, pkg of 20.
53 35 06	Adapter for QRS breathing tubes when using Speedglas welding helmet series 9000.	83 40 17	Breathing tube, heavy-duty rubber, with QRS connection.	83 70 80	Particle filter P SL, pkg of 80.
79 01 01	Product carry bag	83 40 18	Flame resistant breathing tube cover.	83 71 10	Odour filter.
83 31 01	Battery charger for NiMH batteries.	83 45 00	Gasket for non-QRS breathing tubes, not shown, pkg of 5.	83 71 20	Odour filter pad.
83 31 11	Battery charger for Li-ion batteries	83 50 00	Belt.	83 72 42	Gas filter A1B1E1.
83 32 06	6-station battery charger kit for NiMH batteries.	83 50 05	Front part, belt.	83 73 01	Gas filter kit: A1B1E1 filter and Li-ion Heavy-Duty battery.
83 40 00	Breathing tube, lightweight, non-QRS.	83 50 10	Quick connection for belt (not shown).	83 75 42	Gas filter A2.
83 40 05	Breathing tube, heavy-duty rubber, non-QRS.	83 60 00	Spark arrester.	83 76 20	NiMH Battery (standard).
83 40 08	Breathing tube with silencer, non-QRS.	83 60 10	Prefilter, pkg of 5.	83 76 21	NiMH Battery Heavy-Duty.
		83 60 80	Prefilter, pkg of 80.	83 76 30	Li-ion Battery (standard)
		83 70 00	Storage bag.	83 76 31	Li-ion Battery Heavy-Duty.
		83 70 10	Particle filter P SL.	83 80 20	Airflow indicator.
				83 80 31	Filter cover black.

3M™ Versaflo™ Supplied Air Regulator V-500E

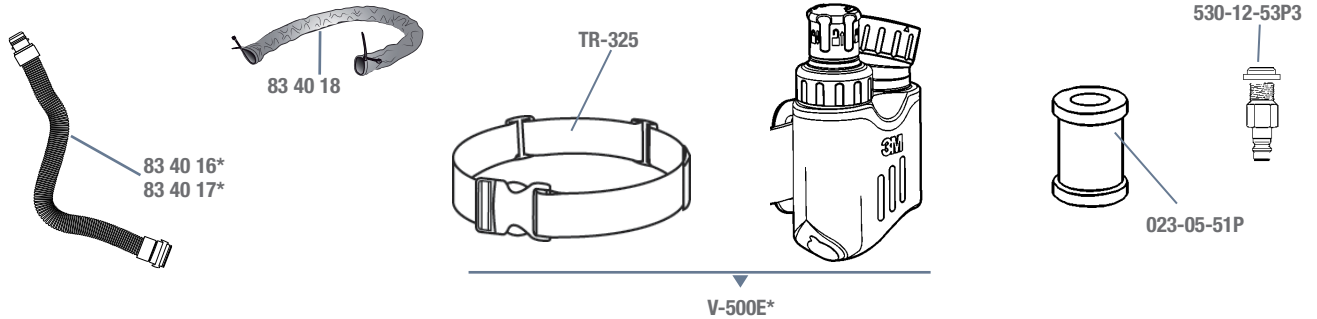

Part No	Description	Part No	Description	Part No	Description
023-05-51P	Carbon filter	83 40 17	Breathing tube, heavy-duty rubber, with QRS connection.	TR-325	Belt
530-12-53P3	Belt unit coupling plug - CEJN	83 40 18	Flame resistant breathing tube cover.	V-500E	Versaflo regulator V-500E with belt.
83 40 16	Breathing tube, self-adjusting (52,5 to 85 cm), with QRS connection.				

* When used with Versaflo headtops M-Series the BT-Series breathing tubes must be used.

Spare parts for 3M™ Fresh-air™ C Supplied Air Regulator

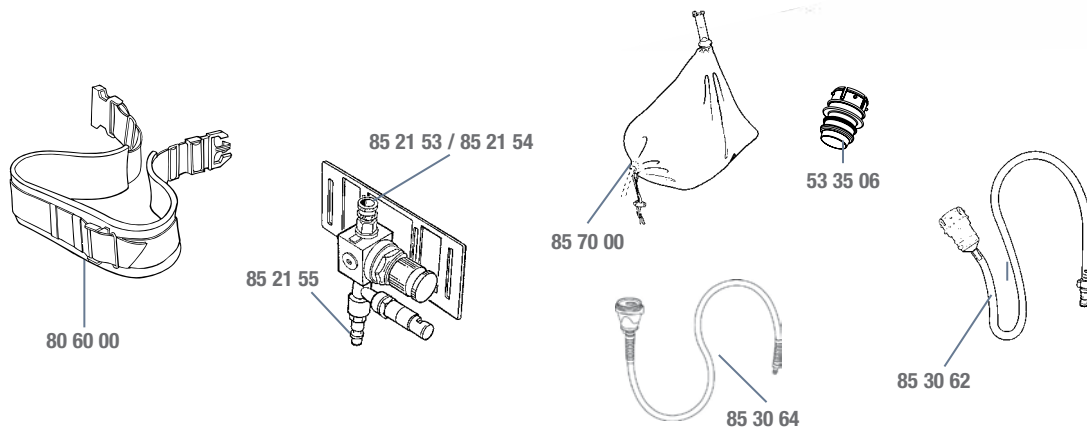

Part No	Description	Part No	Description
53 35 06	Adapter for QRS breathing tubes when using Speedglas welding helmet series 9000.	85 21 55	Nipple regulator CEJN 342.
80 60 00	Comfort belt.	85 30 62	Breathing tube (transparent) with nipple, without QRS connection.
85 21 53	Coupling CEJN 220 1/4.	85 30 64	Breathing tube (blue) with nipple and QRS connection.
85 21 54	Safety coupling CEJN 228 1/4.	85 70 00	Storage bag.

3M™ Filtration Units and Compressed Air Supply Tubes



Part No	Description	Part No	Description
308-00-30P	Standard duty air supply tube, 10 m	530-12-81P3	Socket and plug - CEJN
308-00-31P	Standard duty air supply tube, 30 m	ACU-01	3M™ Aircare™ Filtration System (wall mounted).
308-00-40P	Coiled air supply tube, 7.5 m	ACU-02	3M™ Aircare™ Filtration System (stand alone).
308-00-72P	Standard duty, anti-static, high temperature air supply tube, 10 m		
312-03-00P3	3-way manifold		
312-03-01P3	2-way manifold		

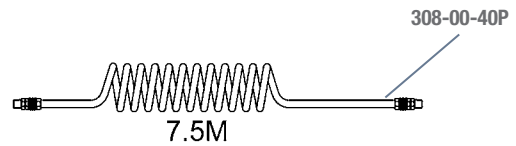
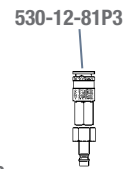
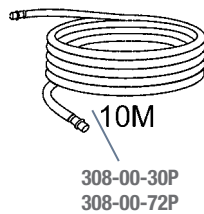
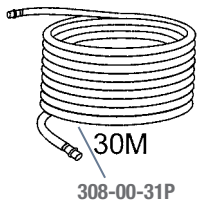

3M™ Speedglas™ Welding Helmet 9100 Air



Part No	Description	Part No	Description	Part No	Description
56 77 00*	Speedglas welding helmet 9100 Air without welding filter, with Adflo powered air respirator.	56 85 00*	Speedglas welding helmet 9100 Air without welding filter, with Versaflor supplied air regulator V-500E.	56 90 05*	Upgrade kit for Adflo respirator: welding helmet with 9100V filter, breathing tube (834016) and carry bag.
56 77 05*	Speedglas welding helmet 9100 Air with 9100V filter and Adflo powered air respirator.	56 85 05*	Speedglas welding helmet 9100 Air with 9100V filter, with Versaflor supplied air regulator V-500E.	56 90 15*	Upgrade kit for Adflo respirator: welding helmet with 9100X filter, breathing tube (834016) and carry bag.
56 77 15*	Speedglas welding helmet 9100 Air with 9100X filter, with Adflo powered air respirator.	56 85 15*	Speedglas welding helmet 9100 Air with 9100X filter, with Versaflor supplied air regulator V-500E.	56 90 25*	Upgrade kit for Adflo respirator: welding helmet with 9100XX filter, breathing tube (834016) and carry bag.
56 77 25*	Speedglas welding helmet 9100 Air with 9100XX filter, with Adflo powered air respirator.	56 85 25*	Speedglas welding helmet 9100 Air with 9100XX filter, with Versaflor supplied air regulator V-500E.		

* With bag (79 01 01)

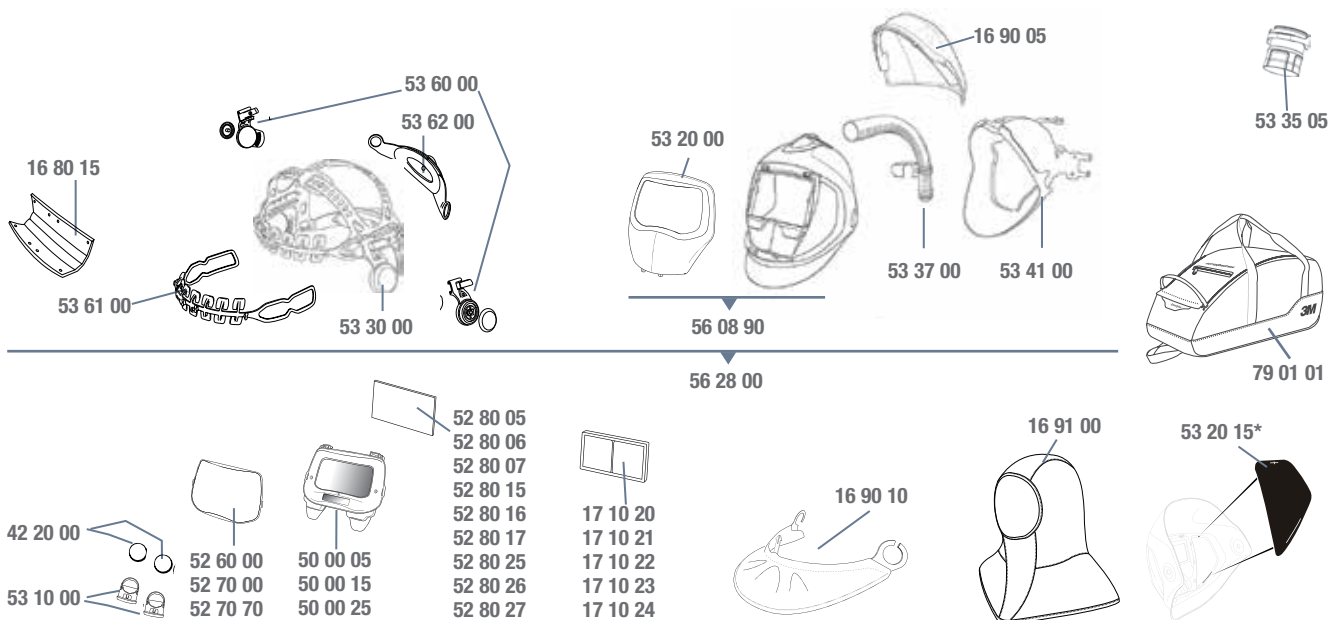

Accessories and spare parts

Part No	Description	Part No	Description	Part No	Description
16 80 15	Comfort sweatband, pkg of 3.	52 80 05	Inner cover plate for 9100V filter, pkg of 5. Plate marking 117x50.	53 10 00	Battery holder, pkg of 2.
16 90 05	Head protection, black.	52 80 06	Inner cover plate, +1 shade for 9100V filters, pkg of 3.	53 20 00	Heat-reflecting silver front.
16 90 10	Neck protection, black.	52 80 07	Inner cover plate, +2 shade for 9100V filters, pkg of 3.	53 20 15*	SideWindows cover plate, 2 pairs.
16 91 00	Hood, black/grey.	52 80 15	Inner cover plate for 9100X filter, pkg of 5. Plate marking 117x61.	53 30 00	Speedglas headband 9100 with assembly parts.
17 10 20	Magnifying lens 1.0.	52 80 16	Inner cover plate, +1 shade for 9100X filter, pkg of 3.	53 35 05	Welding helmet adapter when using old type of breathing tube (non-QRS).
17 10 21	Magnifying lens 1.5.	52 80 17	Inner cover plate, +2 shade for 9100X filter, pkg of 3.	53 37 00	Air duct.
17 10 22	Magnifying lens 2.0.	52 80 25	Inner cover plate for 9100XX filter, pkg of 5. Plate marking 117x77.	53 41 00	Face seal.
17 10 23	Magnifying lens 2.5.	52 80 26	Inner cover plate, +1 shade for 9100XX filter, pkg of 3.	53 60 00	Pivot mechanism, left and right.
17 10 24	Magnifying lens 3.0.	52 80 27	Inner cover plate, +2 shade for 9100XX filter, pkg of 3.	53 61 00	Headband front part.
42 20 00	Battery, pkg of 2.			53 62 00	Headband back part.
50 00 05	Speedglas welding filter 9100V.			56 08 90*	Speedglas welding helmet 9100 Air without headband, without air duct, without face seal, without filter.
50 00 15	Speedglas welding filter 9100X.			56 28 00	Speedglas welding helmet 9100 Air, without welding filter.
50 00 25	Speedglas welding filter 9100XX.			79 01 01	Product carry bag
52 60 00	Outer protection plate, standard, pkg of 10.				
52 70 00	Outer protection plate, extra scratch resistant, pkg of 10.				
52 70 70	Outer protection plate, heat resistant pkg of 10.				

* Please use Part No 56 08 90 when new SideWindows are required.

3M™ Speedglas™ Welding Helmet 9100 FX Air



Part No	Description	Part No	Description	Part No	Description
54 77 00*	Speedglas welding helmet 9100 FX Air, without welding filter, with Adflo powered air respirator.	54 88 00*	Speedglas welding helmet 9100 FX Air, without welding filter, with Versaflo supplied air regulator V-500E.	54 90 05*	Upgrade kit: welding helmet with 9100V filter, breathing tube (834016) and carry bag.
54 77 05*	Speedglas welding helmet 9100 FX Air with 9100V filter, with Adflo powered air respirator.	54 88 05*	Speedglas welding helmet 9100 FX Air with 9100V filter, with Versaflo supplied air regulator V-500E.	54 90 15*	Upgrade kit: welding helmet with 9100X filter, breathing tube (834016) and carry bag.
54 77 15*	Speedglas welding helmet 9100 FX Air with 9100X filter, with Adflo powered air respirator.	54 88 15*	Speedglas welding helmet 9100 FX Air with 9100X filter, with Versaflo supplied air regulator V-500E.	54 90 25*	Upgrade kit: welding helmet with 9100XX filter, breathing tube (834016) and carry bag.
54 77 25*	Speedglas welding helmet 9100 FX Air with 9100XX filter, with Adflo powered air respirator.	54 88 25*	Speedglas welding helmet 9100 FX Air with 9100XX filter, with Versaflo supplied air regulator V-500E.		

*With bag (79 01 01)

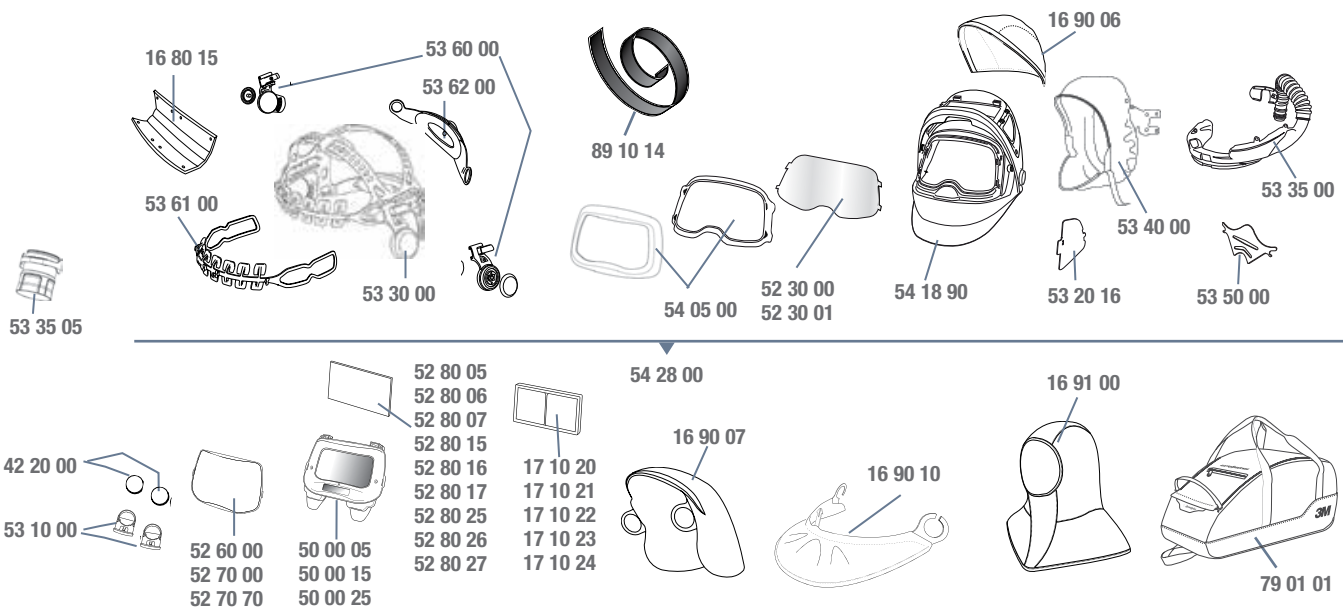

Accessories and spare parts

Part No	Description	Part No	Description	Part No	Description
16 80 15	Comfort sweatband, pkg of 3.	52 80 05	Inner cover plate for 9100V filter, pkg of 5. Plate marking 117x50.	53 35 00	Air duct.
16 90 06	Head protection, (small).	52 80 06	Inner cover plate, +1 shade for 9100V filters, pkg of 3.	53 35 05	Adapter for non-QRS breathing tubes when using Speedglas welding helmet series 9100.
16 90 07	Head protection, (large).	52 80 07	Inner cover plate, +2 shade for 9100V filters, pkg of 3.	53 40 00	Face seal.
16 90 10	Neck protection, black.	52 80 15	Inner cover plate for 9100X filter, pkg of 5. Plate marking 117x61.	53 50 00	Air deflector.
16 91 00	Hood, black/grey.	52 80 16	Inner cover plate, +1 shade for 9100X filter, pkg of 3.	53 60 00	Pivot mechanism, left and right.
17 10 20	Magnifying lens 1.0.	52 80 17	Inner cover plate, +2 shade for 9100X filter, pkg of 3.	53 61 00	Headband, front part.
17 10 21	Magnifying lens 1.5.	52 80 25	Inner cover plate for 9100XX filter, pkg of 5. Plate marking 117x77.	53 62 00	Headband, back part.
17 10 22	Magnifying lens 2.0.	52 80 26	Inner cover plate, +1 shade for 9100XX filter, pkg of 3.	54 05 00	Front cover kit.
17 10 23	Magnifying lens 2.5.	52 80 27	Inner cover plate, +2 shade for 9100XX filter, pkg of 3.	54 18 90	Speedglas welding helmet 9100 FX Air, without filter, without face seal, without air duct, without headband.
17 10 24	Magnifying lens 3.0.	53 10 00	Battery holder, pkg of 2.	54 28 00	Speedglas welding helmet 9100 FX Air, without welding filter, with headband.
42 20 00	Battery, pkg of 2.	53 20 16	SideWindows cover plate, 2 pairs.	79 01 01	Product carry bag.
50 00 05	Speedglas welding filter 9100V.	53 30 00	Speedglas headband 9100, with assembly parts.	89 10 14	Velcro for Head cover, pkg of 2.
50 00 15	Speedglas welding filter 9100X.				
50 00 25	Speedglas welding filter 9100XX.				
52 30 00	Visor plate, standard, pkg of 5.				
52 30 01	Visor plate, anti-fog, pkg of 5.				
52 60 00	Outer protection plate, standard, pkg of 10.				
52 70 00	Outer protection plate, extra scratch resistant, pkg of 10.				
52 70 70	Outer protection plate, heat resistant, pkg of 10.				

3M™ Speedglas™ Welding Helmet 9100 MP



57 90 15

Part No	Description	Part No	Description	Part No	Description
57 66 00*	Speedglas welding helmet 9100 MP without welding filter, with Adflo powered air respirator.	57 88 00*	Speedglas welding helmet 9100 MP without welding filter, with Versaflo supplied air regulator V-500E.	57 90 15*	Speedglas welding helmet 9100 MP with 9100X filter and breathing tube
57 66 05*	Speedglas welding helmet 9100 MP with 9100V filter, with Adflo powered air respirator.	57 88 05*	Speedglas welding helmet 9100 MP with 9100V filter, with Versaflo supplied air regulator V-500E.	57 90 25*	Speedglas welding helmet 9100 MP with 9100XX filter and breathing tube
57 66 15*	Speedglas welding helmet 9100 MP with 9100X filter, with Adflo powered air respirator.	57 88 15*	Speedglas welding helmet 9100 MP with 9100X filter, with Versaflo supplied air regulator V-500E.		
57 66 25*	Speedglas welding helmet 9100 MP with 9100XX filter, with Adflo powered air respirator.	57 88 25*	Speedglas welding helmet 9100 MP with 9100XX filter, with Versaflo supplied air regulator V-500E.		

* With bag (79 01 01)

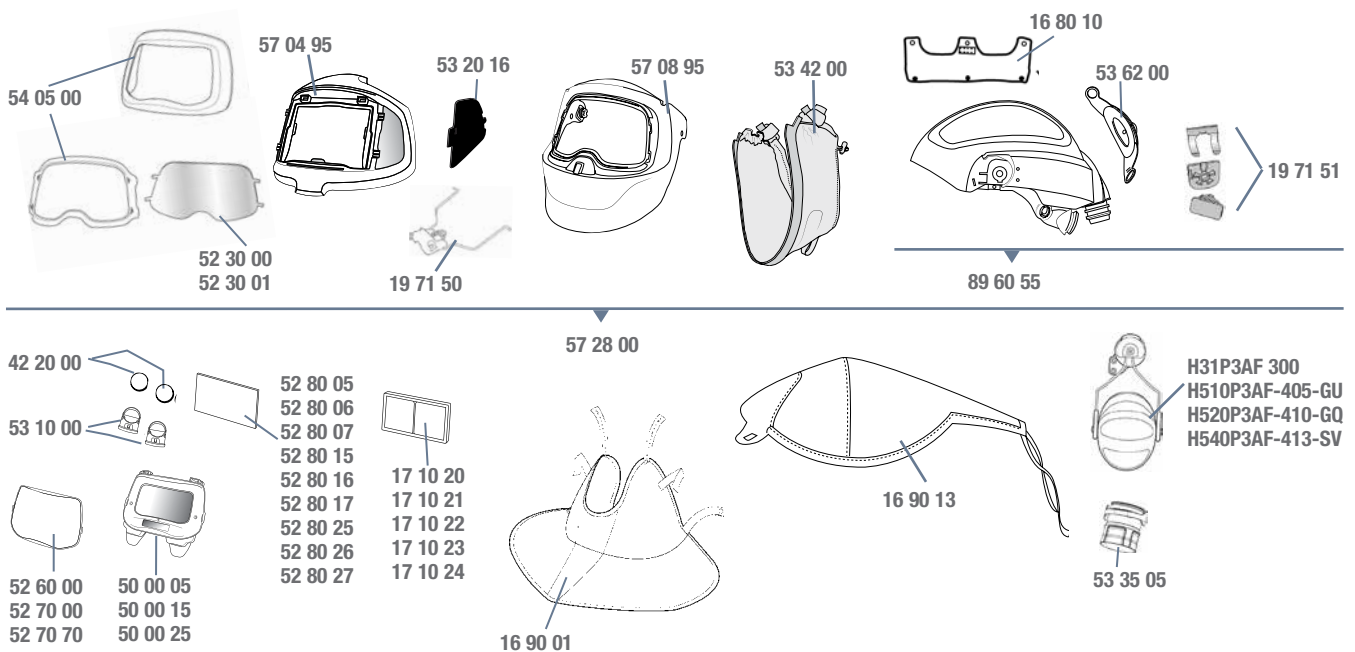

Accessories and spare parts

Part No	Description	Part No	Description	Part No	Description
16 80 10	Sweatband, fleecy cotton	52 70 70	Outer protection plate, heat resistant pkg of 10.	53 20 16	SideWindow cover plates.
16 90 01	Neck protection, black/grey.	52 80 05	Inner cover plate for 9100V filter, pkg of 5. Plate marking 117x50.	53 35 05	Welding helmet adapter when using old type of breathing tube (non-QRS).
16 90 13	Safety helmet cover 9100 MP	52 80 06	Inner cover plate, +1 shade for 9100V filters, pkg of 3.	53 42 00	Face seal
17 10 20	Magnifying lens 1.0.	52 80 07	Inner cover plate, +2 shade for 9100V filters, pkg of 3.	53 62 00	Headband ratchet
17 10 21	Magnifying lens 1.5.	52 80 15	Inner cover plate for 9100X filter, pkg of 5. Plate marking 117x61.	54 05 00	Front cover kit.
17 10 22	Magnifying lens 2.0.	52 80 16	Inner cover plate, +1 shade for 9100X filter, pkg of 3.	57 04 95	Outer shield
17 10 23	Magnifying lens 2.5.	52 80 17	Inner cover plate, +1 shade for 9100X filter, pkg of 3.	57 08 95	Inner shield
17 10 24	Magnifying lens 3.0.	52 80 17	Inner cover plate, +2 shade for 9100X filter, pkg of 3.	57 28 00	Speedglas welding and safety helmet 9100 MP, without welding filter.
19 71 50	Flip-up mechanism	52 80 25	Inner cover plate for 9100XX filter, pkg of 5. Plate marking 117x77.	89 60 55	Safety helmet incl pivot kit
19 71 51	Pivot kit	52 80 26	Inner cover plate, +1 shade for 9100XX filter, pkg of 3.	M-350	Versaflo head suspension M-300 (not shown above)
42 20 00	Battery, pkg of 2.	52 80 27	Inner cover plate, +2 shade for 9100XX filter, pkg of 353 10 00	H31P3AF300	Peltor hearing protector H31, with helmet attachment
50 00 05	Speedglas welding filter 9100V.		Battery holder, pkg of 2.	H510P3AF-405-GU	Peltor hearing protector Optime I, with helmet attachment
50 00 15	Speedglas welding filter 9100X.			H520P3AF-410-GQ	Peltor hearing protector Optime II, with helmet attachment
50 00 25	Speedglas welding filter 9100XX.			H540P3AF-413-SV	Peltor hearing protector Optime III, with helmet attachment
52 30 00	Visor plate, standard, pkg of 5.				
52 30 01	Visor plate, anti-fog, pkg of 5.				
52 60 00	Outer protection plate, standard, pkg of 10.				
52 70 00	Outer protection plate, extra scratch resistant, pkg of 10.				

3M™ VersaFlo™ Headtops M-Series



M-107

M-307

Part No	Description	Part No	Description	Part No	Description
84 77 20	VersaFlo Faceshield M-107 with Adflo respirator	85 77 20	VersaFlo Helmet M-307 with Adflo respirator	M-107*	VersaFlo Faceshield M-107
				M-307*	VersaFlo Helmet M-307

* For supplied air respirator system, please see page 51 to order regulator.

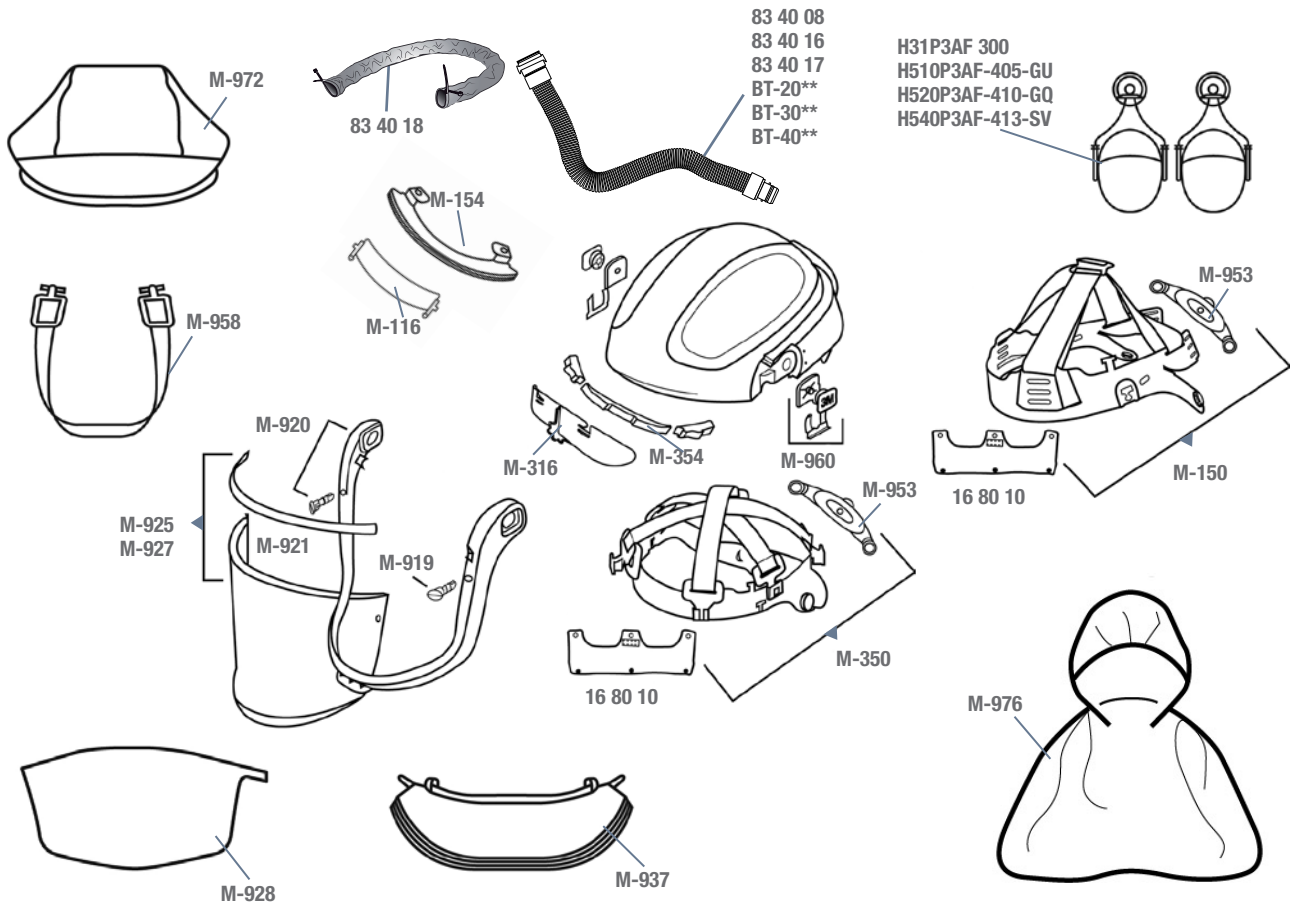

Accessories and spare parts

Part No	Description	Part No	Description	Part No	Description
16 80 10	Sweatband, fleecy cotton, pkg of 2	M-150	Head suspension (M-107)	M-960	Pivot kit
83 40 08	Breathing tube with silencer, non-QRS.	M-154	Forehead seal (M-107)	M-972	Flame resistant headtop cover
83 40 16	Breathing tube, self-adjusting (52,5 to 85 cm), with QRS connection.	M-316	Airflow deflector (M-307)	M-976	Head, neck and shoulder cover
83 40 17	Breathing tube, heavy-duty rubber, with QRS connection.	M-350	Head suspension (M-307)	H31P3AF300	Peltor H31 Hearing Protector, with helmet attachment
83 40 18	Flame resistant breathing tube cover.	M-354	Forehead seal (M-307)	H510P3AF-405-GU	Peltor Optime I Hearing Protector, with helmet attachment
BT-20 S&L**	Breathing tube, polyurethane (in two lengths), with QRS connection.	M-919	Visor frame buttons	H520P3AF-410-GQ	Peltor Optime II Hearing Protector, with helmet attachment
BT-30**	Breathing tube, self-adjusting (52,5 to 85 cm), with QRS connection.	M-920	Visor frame	H540P3AF-413-SV	Peltor Optime III Hearing Protector, with helmet attachment
BT-40**	Breathing tube, heavy-duty rubber, with QRS connection.	M-921	Visor gasket		
M-116	Airflow deflector (M-107)	M-925	Visor standard (uncoated), molten metal splash protection to EN166.		
		M-927	Visor coated		
		M-928	Peel-off visor cover		
		M-937	Flame resistant faceseal		
		M-953	Ratchet		
		M-956	Ratchet comfort pad		
		M-958	Chin strap		

** When used with 3M™ VersaFlo™ Supplied Air Regulator V-500E, the 3M™ VersaFlo™ Breathing Tubes BT-series must be used.

3M™ Protective Visor with 3M™ Adflo™ Respirator



Part No	Description
16 40 09	Head protection flame-resistant.
16 80 12	Sweatband.
80 30 10	Headband, with air duct.
80 30 60	Headband, without air duct.
80 40 05	Face seal.
89 10 13	Velcro face seal, pkg of 2.
89 90 25	Protective Visor, DIN 5, polycarbonate, with Adflo Respirator.
89 90 35	Protective Visor, DIN 5, polycarbonate, with head protection.
89 90 40	Protective Visor, clear, polycarbonate, with face seal, without brow protection.
89 90 41	Protective Visor, clear, acetate, with face seal, without brow protection.
89 90 45	Protective Visor, DIN 5, polycarbonate, with face seal, without brow protection.
89 90 51	Brow protection.
89 90 60	Protection film, pkg of 5.

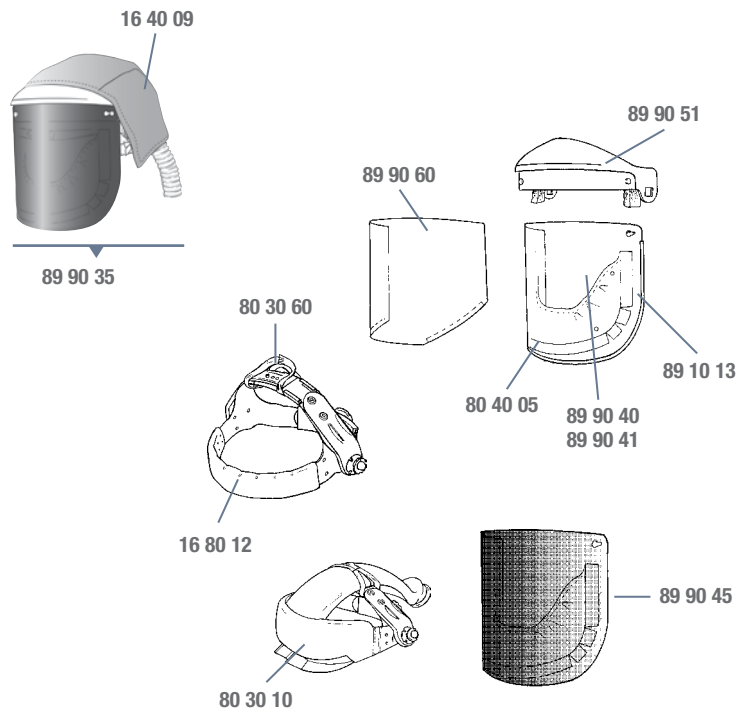

Spare parts for 3M™ Protective Visor and 3M™ Fresh-air C Regulator*



Part No	Description
16 40 09	Head protection, flame-resistant.
16 80 12	Sweatband.
80 30 60	Headband, without air duct.
80 40 05	Face seal.
85 30 56	Breathing tube, with nipple, silencer and fastening details.
89 10 13	Velcro face seal, pkg of 2.
89 90 60	Protection film, pkg of 5.
89 91 35	Protective Visor, DIN5, polycarbonate, with head protection.
89 91 40	Protective Visor, clear, polycarbonate, with face seal, without brow protection.
89 91 41	Protective Visor, clear, acetate, with face seal, without brow protection.
89 91 45	Protective Visor DIN 5, polycarbonate, with face seal, without brow protection.
89 91 51	Brow protection.

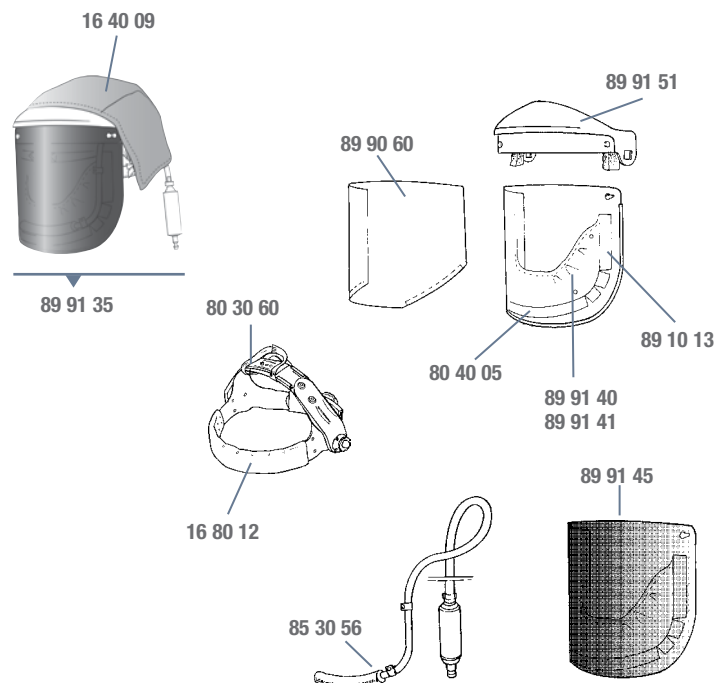

* Fresh-air C regulator no longer available

3M™ Speedglas™ Welding Filter Adapter 9100 for Passive Lens

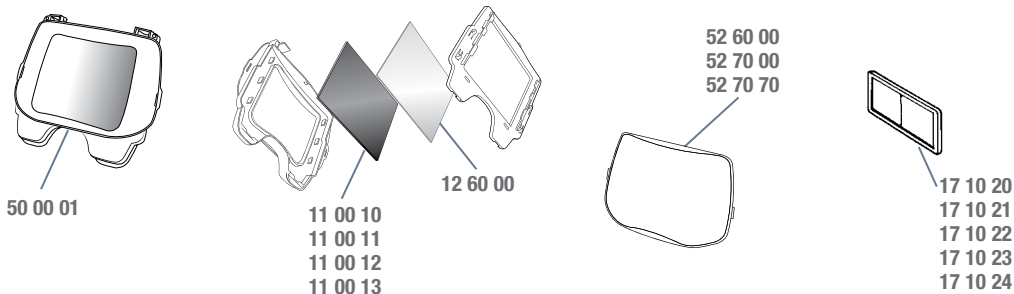

Part No	Description	Part No	Description	Part No	Description
11 00 10	Passive welding filter lens shade 10.	17 10 22	Magnifying lens 2.0.	52 70 00	Outer protection plate, extra scratch resistant, pkg of 10.
11 00 11	Passive welding filter lens shade 11.	17 10 23	Magnifying lens 2.5.	52 70 70	Outer protection plate, heat resistant pkg of 10.
11 00 12	Passive welding filter lens shade 12.	17 10 24	Magnifying lens 3.0.		
11 00 13	Passive welding filter lens shade 13.	50 00 01	Speedglas welding filter adaptor 9100 for passive lens (shade 11).		
12 60 00	Outer protection plate	52 60 00	Outer protection plate, standard, pkg of 10.		
17 10 20	Magnifying lens 1.0.				
17 10 21	Magnifying lens 1.5.				

3M™ Speedglas™ 9000 Series Welding Helmets for Respiratory Protection with Safety Helmet

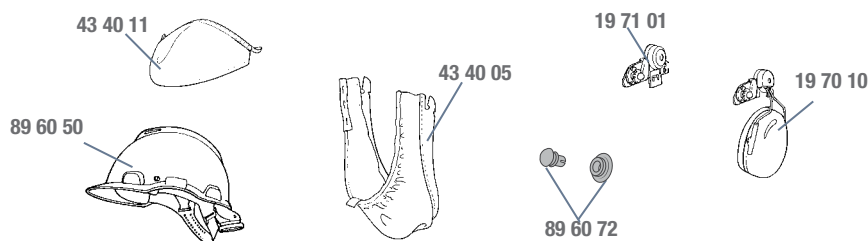

Part No	Description	Part No	Description	Part No	Description
19 70 10	Ear muffs for safety helmet with assembly parts.	43 40 05	Face seal	89 60 72	Fastening details for face seal
19 71 01	Fastening details for safety helmet with assembly parts.	43 40 11	Helmet seal in leather for Speedglas welding helmet with safety helmet.		
		89 60 50	Safety helmet with air duct.		

3M™ Speedglas™ Welding Helmets 9000 Series for Respiratory Protection



Accessories and spare parts*

Part No	Description	Part No	Description	Part No	Description
16 40 05	Ear and neck protection in leather.	42 70 00	Outer protection plate, scratch resistant, pkg of 10. Plate marking 42 01 00.	43 30 10	Air duct.
16 40 09	Head protection.	42 70 71	Outer protection plate, heat resistant, pkg of 10. Plate marking 42 01 71.	43 30 60	Headband without air duct.
16 60 20	Assembly parts for headband.	42 80 00	Inner cover plate (42x91 mm) for 9002D/9002V Filters, pkg of 5. Plate marking 42 02 00.	43 40 01	Face seal.
16 75 20	Sweatband, towelling, pkg of 2.	42 80 10	Inner cover plate (53x103 mm) for 9002X/9000XF Filters, pkg of 5. Plate marking 42 02 10.	43 50 00	Air spreader.
16 76 00	Sweatband, towelling, pkg of 20.	42 80 20	Inner cover plate, +1 Shade, for 9002D/9002V Filters, pkg of 5.	44 28 00	9000 FlexView welding helmet for respiratory protection, without filter.
16 80 00	Sweatband, leather.	42 80 30	Inner cover plate, +1 Shade, for 9002X/9000XF Filters, pkg of 5.	44 28 91	Speedglas FlexView welding helmet for respiratory protection with passive welding filter, shade 11.
16 80 12	Sweatband, fleecy cotton, pkg of 2.	42 80 40	Inner cover plate, +2 Shade, for 9002D/9002V Filters, pkg of 5.	44 30 00	Passive welding filter shade 11 (not shown).
16 90 01	Neck protection black/grey.	42 80 50	Inner cover plate, +2 Shade, for 9002X/9000XF Filters, pkg of 5.	46 08 00	9000 welding helmet for respiratory protection, without welding filter.
16 91 00	Hood black/grey.	43 10 00	Battery cover, pkg of 2.	46 08 90*	9000 welding helmet without headband, without airduct.
17 10 20	Magnifying lens 1.0.	43 20 00	Heat-reflecting, front silver.	80 31 10	Tightening kit for Speedglas 9000 welding helmet, not shown.
17 10 21	Magnifying lens 1.5.	43 20 15*	SideWindows cover plate (sticker), 5 pairs.		
17 10 22	Magnifying lens 2.0.	43 30 00	Headband with air duct.		
17 10 23	Magnifying lens 2.5.				
17 10 24	Magnifying lens 3.0.				
40 00 40	Speedglas 9002D welding filter, dual shade 9/11.				
40 00 70	Speedglas 9002V welding filter, variable shade 9-13.				
40 00 80	Speedglas 9002X welding filter, variable shade 9-13.				
42 20 00	Battery, pkg of 2.				
42 60 00	Outer protection plate, standard, pkg of 10. Plate marking 42 01 50.				

* Please use Part No 46 08 90 to replace the SideWindows.

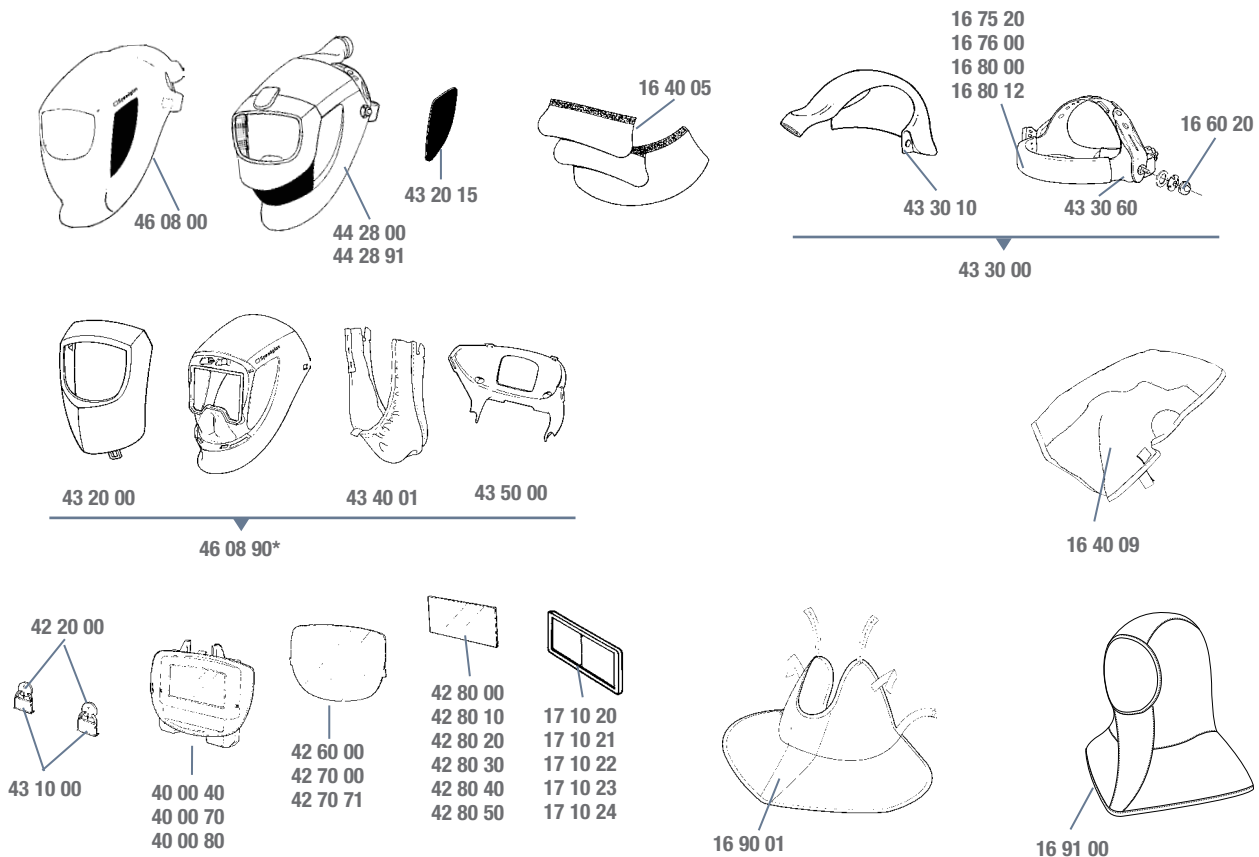

* Speedglas 9100, 9100 Air, 9100 FX and 9100 FX Air Welding Helmets replaces the Speedglas 9000 and 9000 FlexView Welding Helmets. Accessories and spare parts for 9000 series available for 3-5 years.

3M™ 600 Series Welding Helmets for 3M™ Jupiter™ Powered Air Respirator



HT-622



HT-629



HT-639



WLD-08

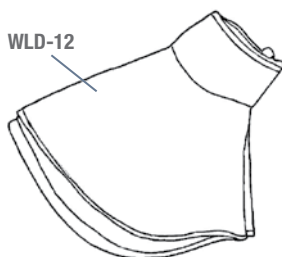

WLD-12

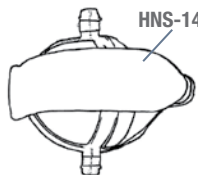

HNS-14



WLN-14
WLN-15
WLN-17



WLD-10



WLD-13



WLN-13

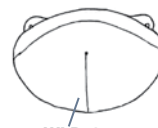

WLD-15

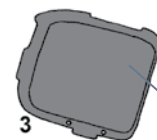

VIS-21
VIS-22
VIS-23
VIS-24



WLD-11



FSL-22
FSL-23

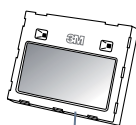

75 00 10
75 00 11
75 00 20

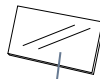

42 80 00
42 80 20
42 80 40



73 10 00



CMF-09

Part No	Description	Part No	Description	Part No	Description
42 20 00	Battery, pkg of 2.	HT-629	Welding helmet, with clear visor plate and 90 x 110 mm welding filter holder, without welding filter.	WLD-13	Filter retainer for HT-639 Helmet.
42 80 00	Inner cover plate, pkg of 5. Plate marking 42 02 00.	HT-639	Welding helmet, with clear visor plate and 90 x 110 mm flip-up welding filter holder, without welding filter.	WLD-15	Leather head cover for HT-622/629 Helmets.
42 80 20	Inner cover plate, +1 shade, pkg of 5.	HNS-14	Headharness with air duct for HT-622/629/639 Helmets.	WLN-13	Outer protection plate (90x110 mm) for HT-629/639 Helmets.
42 80 40	Inner cover plate, +2 shade, pkg of 5.	HTS-19	Spares pack for headharness.	WLN-14	Shade 8, passive welding filter for HT-622 Helmet.
73 10 00	Battery cover.	VIS-21	Clear visor plate for HT-629 Helmet.	WLN-15	Shade 10, passive welding filter for HT-622 Helmet.
75 00 10	Speedglas 100S-10 Auto-darkening Welding Filter, single shade 10.	VIS-22	Shade 1.7 visor plate for HT-622 Helmet.	WLN-17	Shade 5, passive welding filter for HT-622.
75 00 11	Speedglas 100S-11 Auto-darkening Welding Filter, single shade 11.	VIS-23	Shade 3 visor plate for HT-622 Helmet.	WLN-20	Inner cover plate (90 x 110 mm) for HT-639.
75 00 20	Speedglas 100V Auto-darkening Welding Filter, variable shade 8-12	VIS-24	Shade 5 visor for HT-622 Helmet.		
CMF-09	Comfort pads for headharness.	WLD-08	Over visor for HT-629 helmet.		
FSL-22	Faceseal for HT-622/629 Helmets.	WLD-10	Welding filter holder for HT-622 Helmet		
FSL-23	Faceseal for HT-639 Helmet.	WLD-11	Leather neck protector for HT-622/629 Helmets.		
HT-622	Welding helmet with shade 1.7 visor plate and shade 8, passive welding filter.	WLD-12	Welding cape.		



Care and Maintenance

Every day welding sparks, heat, fumes, and normal wear-and-tear grind away at your protection equipment. Therefore, we designed all 3M™ Speedglas™ Personal Protective Equipment with ease of maintenance in mind. All replacement parts can be installed by hand, without tools. For maximum safety and comfort, make it a regular habit to check and change the following items at the intervals recommended below.



Visit us at: www.youtube.com/3MSpeedglas

System	Component	Typically replaced	Notes
Welding Filters	Outer Protection Plate	Once a week	Replace anytime the plate becomes deeply pitted, scratched or too dirty to clean with soft cloth or lens paper.
Welding Filters	Inner Cover Plate	Once a month	Regularly clean with a soft cloth and replace if any pits or scratches occur.
Welding Helmets	Visor Plate	Every two weeks	Replace more often if visibility is reduced.
Welding Helmets	Sweatband	Once a month	Replace more often if sweatband becomes unhygienic.
Respirators	Prefilter	Once a week	Regular replacement of the prefilter extends the life of the particle filter, saving money while also increasing the battery run-time.
Respirators	Particle Filter	At least every month	For Adflo, replace when particle filter indicator becomes red. Otherwise, replace whenever the battery operating time becomes too short, or when "fully loaded" filter triggers low airflow alarm.
Respirators	Gas Filter	As needed	Replace the gas filter according to your work place requirements. It is not recommended to wait until you can feel odours and smell.
Respirators	Odour filter	Any time you smell unpleasant odours	Odour filter is not required if gas filter is used.
Respirators	Spark arrestor	As needed	Replace if deformed and no longer fitting well.
Respirators	Breathing Tube	If damaged, deformed or leaking any air	To extend the life of breathing tube, use a tube cover or a heavy-duty rubber breathing tube.
Welding Helmets with Respirators	Face Seal	At least every 2 months	Replace earlier in really dirty environments or whenever the seal becomes unhygienic.

Important information. Note that higher-than-normal levels of pollutants, heat, and sparks will require more frequent replacement of components. Chart assumes minimum 4 hours usage per day. Ordering information for each series of welding helmet can be found in the Parts Directory.

Technical Specifications of 3M™ Air Delivery Units for Welding Safety

Technical Specifications	3M™ Adflo™ Powered Air Respirator	3M™ Versaflo™ Supplied Air Regulator V-500E
Filters	Particle filter Gas Filter (A1B1E1 or A2) Odour filter	N/A
Airflow	170 l/min (Nominal) 200 l/min (Airflow Plus Mode)	170 - 305 l/min
Air Pressure Air Quality	N/A N/A	3,5–8 bar Breathable supplied air conforming to EN12021
Weight Respirator / Regulator	950 g	514 g
Battery Charging time Operating hours*	Li-ion 4 - 5,5 h 8 hours (Standard), 12 hours (Heavy Duty)	N/A
Belt Optional extension	Leather, 75–115 cm + 25 cm	Polyester, 75–127 cm
Temperature range Operation Storage	-5° C to + 55° C -20° C to + 55° C	-5° C to + 40° C -10° C to + 50° C

* Run times are with new, fully-charged batteries and new filters.

Technical Specifications of 3M™ Protective Visors and Faceshields

Technical Specifications	3M™ Versaflo™ Faceshield M-107	3M™ Versaflo™ Helmet M-307	3M™ Speedglas™ Protective Visor (shade 5)
Material Visor Face seal	Clear coated polycarbonate Flame resistant polyester	Clear coated polycarbonate Flame resistant polyester	Shade 5 polycarbonate Flame resistant cotton
Approval Eye and Face protection Protective Visor (M-927) Protective Visor (M-925) Protective Visor shade 5	EN 166 1:BT:3 EN 166 1:BT:3:9 N/A	EN 166 1:BT:3 EN 166 1:BT:3:9 N/A	N/A N/A EN 166 1:BT:3:9
Approval Head protection Helmet	N/A	EN 397	N/A
Approval Respiratory Protection / NPF* Adflo powered air respirator Versaflo supplied air regulator V-500E	EN 12941 (TH2) / NPF 50 EN 14594 2B / NPF 50	EN 12941 (TH2) / NPF 50 EN 14594 3B / NPF 200	EN 12941 (TH2) / NPF 50 N/A

* The nominal protection factor based on laboratory-measured performance data according to European Standards.
The assigned protection factor is assigned by local authorities in each European country and can therefore be different for each country.

3M™ Speedglas™ Welding Helmets and Welding Filters

- Best*****
- Better*****
- Good*****
- Not Recommended*****



Welding Filter Options	3M™ Speedglas™ Welding Helmets 9100 FX and 9100 FX Air			3M™ Speedglas™ Welding Helmets 9100 and 9100 Air			3M™ Speedglas™ Welding Helmet 9100 MP
	9100XX Filter	9100X Filter	9100V Filter	9100XX Filter	9100X Filter	9100V Filter	9100XX Filter
MMAW (Electrode)							
MIG/MAG							
TIG (>20A)							
TIG (1A-20A)							
Plasma (welding and cutting)							
Risk for hidden arc							
Tack welding							
Grinding (welding filer)							
Grinding (clear visor)				N/A	N/A	N/A	
Viewing area (welding filter)	73 x 107 mm	54 x 107 mm	45 x 93 mm	73 x 107 mm	54 x 107 mm	45 x 93 mm	73 x 107 mm
Battery lifetime	2 000 hours	2 500 hours	2 800 hours	2 000 hours	2 500 hours	2 800 hours	2 000 hours
Solar cell	No	Yes	Yes	No	Yes	Yes	No
Safety Helmet options	No			Yes (non air version)			Yes
Classification	1 / 1 / 1 / 2			1 / 1 / 1 / 2			1 / 1 / 1 / 2
Dark state	Shade 5, 8, 9–13			Shade 5, 8, 9–13			Shade 5, 8, 9–13
Light state	Shade 3			Shade 3			Shade 3
UV/IR Protection	Shade 13 (permanent)			Shade 13 (permanent)			Shade 13 (permanent)
Auto ON	No			No			No
Switching time, light -dark	0,1 ms (+23° C)			0,1 ms (+23° C)			0,1 ms (+23° C)
Delay (switching time, dark-light)	40–1 300 ms			40–1 300 ms			40–1 300 ms
SideWindows option	Yes			Yes			Yes
Exhaust vents	Yes (non air version)			Yes (non air version)			Yes (non air version)
Number of sensors (arc detection)	3			3			3
Approvals Eye and Face protection Welding helmet Welding filter Protection plates Visor plate	EN175:B, EN 166:B EN 379 EN166:BT* EN166:BT*			EN175:B EN 379 EN166:BT* N/A			EN175:B, EN 166 B EN 379 EN166:BT* EN166:BT*
Approval Head protection Safety helmet	N/A			N/A			EN 397 44Vac, LD
Approval Respiratory Protection / NPF** Adflo Powered Air Respirator Versaflo V-500 Supplied Air Regulator	with Speedglas welding helmet 9100 FX Air EN 12941 (TH3) / NPF 500 EN 14594 (3B)/ NPF 200			with Speedglas welding helmet 9100 Air EN 12941 (TH2) / NPF 50 Soon available			EN12941(TH3) /NPF 500 EN14594(3B)/ NPF 200

* According to the European Standards the mechanical strength (for this product) is classified as B; resistance to high speed particles at medium energy impact (120 m/s). The letter T indicates that the test for resistance to high speed particle was conducted at extremes of temperatures (-5° to +55°C).

** The nominal protection factor based on laboratory-measured performance data according to European Standards. The protection factor is assigned by local authorities in each European country and can therefore be different for each country.

*** The ratings (good - better - best) above refer to the products listed in this chart and should be seen as general recommendations based on differences in product comfort features and configuration options when using these selected Speedglas welding helmet series.



3M™ Speedglas™ Welding Helmet 9100 MP		3M™ Speedglas™ Welding Helmet	3M™ Speedglas™ Welding Helmet Series 9000			3M™ Speedglas™ Welding Helmet Series 100	
9100X Filter	9100V Filter	SL Filter	9002X Filter	9002V Filter	9002D Filter	100V Filter	100S Filters
		N/A	Speedglas 9000 FlexView			N/A	N/A
54 x 107 mm	45 x 93 mm	42 x 93 mm	55 x 107 mm	42 x 93 mm		44 x 93 mm	
2 500 hours	2 800 hours	1 500 hours	3 000 hours	1 500 hours		1 500 hours	
Yes		No	Yes	No		No	
Yes		No	Yes			Yes	
1 / 1 / 1 / 2		1 / 1 / 1 / 2	1 / 1 / 2 / 2	1 / 1 / 1 / 2	1 / 2 / 2 / 3	1 / 2 / 2 / 2	
Shade 5, 8, 9–13		Shade 8–12	Shade 9–13		Shade 9/11	Shade 8–12	Shade 10 or 11
Shade 3		Shade 3	Shade 3			Shade 3	
Shade 13 (permanent)		Shade 12 (permanent)	Shade 13 (permanent)			Shade 12 (permanent)	
No		Yes	No			No	
0,1 ms (+23° C)		0,1 ms (+23° C)	0,1 ms (+23° C)		0,4 ms (+23° C)	0,1 ms (+23° C)	
40–1 300 ms		60–250 ms	60–500 ms		100 and 200 ms	60–250 ms	100 or 200 ms
Yes		No	Yes			No	
Yes (non air version)		No	Yes (non air version)			No	
3		2	2			2	
EN175:B, EN 166 B EN 379 EN166:BT* EN166:BT*		EN 175:F EN 379 EN166:FT N/A	EN 175:B (without SideWindows), EN 175:F (with SideWindows) EN 379, EN 166:BT* EN166:BT (Speedglas 9000 FlexView)			EN 175:B EN 379 EN 166:BT* N/A	
EN 397 44Vac, LD		N/A	with Speedglas welding helmet 9000 ProTop EN 397				
EN12941 (TH3) /NPF 500 EN14594 (3B) / NPF		N/A	with Speedglas welding helmet 9000 EN12941 (TH2) / NPF 50 N/A			N/A	

Product Index

Part No	3M ID No	Page	Part No	3M ID No	Page
023-05-51P	52000017559	51	312-03-00P3	52000040098	52
11 00 10	52000194515	58	312-03-01P3	52000040114	52
11 00 11	52000194523	58	40 00 40	52000174723	47, 59
11 00 12	52000194531	58	40 00 70	52000163478	47, 59
11 00 13	52000194549	58	40 00 80	52000163239	47, 59
12 60 00	52000193574	58	40 11 40	52000174731	47
16 40 05	52000166745	45, 46, 47, 59	40 11 90	52000167065	47
16 40 09	52000166695	45, 47, 57, 59	40 18 40	52000174749	47
16 60 20	52000176140	59	40 18 90	52000166802	46, 47
16 75 20	52000166539	45, 46, 47, 59	42 20 00	52000166505	42,43,45,46,47,53,54,55,59,60
16 75 50	52000167776	48	42 30 00	52000167024	46
16 76 00	52000171554	45, 46, 47, 59	42 60 00	52000166471	47, 59
16 80 00	52000166687	45, 46, 47, 59	42 70 00	52000166513	47, 59
16 80 10	52000166737	45, 46, 47, 55, 56	42 70 71	52000174921	47, 59
16 80 12	52000185117	57, 59	42 80 00	52000166497	45, 46, 47, 59, 60
16 80 15	52000182080	42, 43, 53, 54,	42 80 05	52000167958	46
16 90 01	52000166877	45, 46, 47, 55, 59	42 80 10	52000166547	47, 59
16 90 05	52000182205	42, 53	42 80 20	52000167172	45, 47, 59, 60
16 90 06	52000187048	43, 54	42 80 30	52000167313	47, 59
16 90 07	52000187055	43, 54	42 80 40	52000167248	45, 47, 59, 60
16 90 10	52000182213	42, 43, 53, 54	42 80 50	52000167420	47, 59
16 90 13	52000191354	55	43 10 00	52000167354	47, 59
16 91 00	52000166943	42, 43, 45, 46, 47, 53, 54, 59	43 20 00	52000166968	47, 59
17 10 15	52000167388	47	43 20 15	52000167263	47, 59
17 10 17	52000183716	45	43 30 00	52000166984	59
17 10 20	52000167230	42, 43, 45, 46, 47, 53, 54, 55, 58, 59	43 30 10	52000167164	59
17 10 21	52000167099	42, 43, 45, 46, 47, 53, 54, 55, 58, 59	43 30 60	52000167107	59
17 10 22	52000167131	42, 43, 45, 46, 47, 53, 54, 55, 58, 59	43 40 01	52000174939	59
17 10 23	52000167198	42, 43, 45, 46, 47, 53, 54, 55, 58, 59	43 40 05	52000174947	58
17 10 24	52000167875	42, 43, 45, 46, 47, 53, 54, 55, 58, 59	43 40 11	52000167784	58
17 10 31	52000183914	46	43 50 00	52000167610	59
19 67 05	52000168089	48	44 05 00	52000166810	46
19 70 10	52000167867	58	44 10 00	52000167321	46
19 71 01	52000167503	58	44 20 00	52000167347	46
19 71 30	52000167214	48	44 28 00	52000165200	59
19 71 31	52000167206	48	44 28 91	52000165432	59
19 71 35	52000193822	48	44 30 00	52000165226	59
19 71 36	52000193681	48	46 08 00	52000165143	59
19 71 37	52000193673	48	46 08 90	52000167545	59
19 71 40	52000167297	46	48 28 00	52000167925	48
19 71 41	52000174962	46	48 31 00	52000163965	48
19 71 50	52000191313	55	48 38 00	52000163544	48
19 71 51	52000191305	55	48 38 70	52000164294	48
308-00-30P	52000040015	52	48 38 80	52000164674	48
308-00-31P	52000040023	52	50 00 01	52000193715	58
308-00-40P	52000040056	52	50 00 05	52000182031	42, 43, 53, 54, 55
308-00-72P	52000040049	52	50 00 15	52000182049	42, 43, 53, 54, 55

Product Index

Part No	3M ID No	Page
50 00 25	52000182056	42, 43, 53, 54, 55
50 11 00	52000182015	42
50 11 05	52000181959	42
50 11 15	52000181967	42
50 11 25	52000181975	42
50 11 90	52000182122	42
50 18 00	52000182023	42
50 18 05	52000181983	42
50 18 15	52000181991	42
50 18 25	52000182007	42
50 18 90	52000182130	42
52 30 00	52000186982	43, 54, 55
52 30 01	52000189143	43, 54, 55
52 60 00	52000182064	42, 43, 53, 54, 55, 58
52 70 00	52000182072	42, 43, 53, 54, 55, 58
52 70 70	52000182288	42, 43, 53, 54, 55, 58
52 80 05	52000182098	42, 43, 53, 54, 55
52 80 06	52000192550	42, 43, 53, 54, 55
52 80 07	52000192568	42, 43, 53, 54, 55
52 80 15	52000182106	42, 43, 53, 54, 55
52 80 16	52000192576	42, 43, 53, 54, 55
52 80 17	52000192584	42, 43, 53, 54, 55
52 80 25	52000182114	42, 43, 53, 54, 55
52 80 26	52000192592	42, 43, 53, 54, 55
52 80 27	52000192600	42, 43, 53, 54, 55
530-12-53P3	52000018599	51
530-12-81P3	52000018557	52
53 10 00	52000182197	42, 43, 53, 54
53 20 00	52000182163	42, 53
53 20 15	52000182296	42, 53
53 20 16	52000187030	43, 54, 55
53 30 00	52000191784	42, 43, 53, 54
53 35 00	52000186990	54
53 35 05	52000187071	50, 53, 54, 55
53 35 06	52000187584	50, 51
53 37 00	52000189630	53
53 40 00	52000186974	54
53 41 00	52000189622	53
53 42 00	52000191297	55
53 50 00	52000189762	54
53 60 00	52000191792	42, 43, 53, 54
53 61 00	52000183088	42, 43, 53, 54
53 62 00	52000183096	42, 43, 53, 54, 55
54 05 00	52000187022	43, 54, 55
54 18 00	52000189036	43
54 18 05	52000189044	43
54 18 15	52000186909	43

Part No	3M ID No	Page
54 18 25	52000186917	43
54 18 90	52000186925	43
54 28 00	52000186966	54
54 38 05	52000193640	48
54 38 15	52000193657	48
54 38 25	52000193665	48
54 77 00	52000193848	54
54 77 05	52000193855	54
54 77 15	52000193863	54
54 77 25	52000193871	54
54 88 00	52000189093	54
54 88 05	52000189069	54
54 88 15	52000189077	54
54 88 25	52000189085	54
54 90 05	52000177254	54
54 90 15	52000177262	54
54 90 25	52000177270	54
56 08 90	52000189572	53
56 28 00	52000189580	53
56 77 00	52000193889	53
56 77 05	52000193897	53
56 77 15	52000193905	53
56 77 25	52000193913	53
56 85 00		53
56 85 05		53
56 85 15		53
56 85 25		53
56 90 05	52000190562	53
56 90 15	52000190570	53
56 90 25	52000190588	53
57 04 95	52000191339	55
57 08 95	52000191321	55
57 28 00	52000191206	55
57 66 00	52000191214	55
57 66 05	52000191222	55
57 66 15	52000191230	55
57 66 25	52000191248	55
57 88 00	52000191255	55
57 88 05	52000191263	55
57 88 15	52000191271	55
57 88 25	52000191289	55
57 90 15	52000192345	55
57 90 25	52000192352	55
58 38 05	52000193806	48
58 38 15	52000193798	48
58 38 25	52000193780	48
70 00 20	52000175548	46

Product Index

Part No	3M ID No	Page	Part No	3M ID No	Page
70 11 20	52000175530	46	78 31 20	52000193814	48
70 11 90	52000175571	46	79 01 01	52000189176	50, 53, 54
70 50 15	52000191537	45, 46, 47	80 30 10	52000167834	57
70 60 00	52000175597	45, 46, 47	80 30 60	52000167479	57
70 62 02	52000176645	46	80 31 10	52000167280	59
72 60 00	52000175555	46	80 40 05	52000174954	57
72 70 00	52000175563	46	80 60 00	52000166828	51
73 10 00	52000175605	45, 46, 60	83 31 11	52000194069	50
75 00 10	52000192964	45, 60	83 32 06	52000167735	50
75 00 11	52000193012	45, 60	83 40 00	52000166794	50
75 00 20	52000193046	45, 60	83 40 05	52000167081	50
75 05 11	52000188467	45	83 40 08	52000176785	50, 56
75 11 00	52000183625	45	83 40 16	52000189150	50, 51, 56
75 11 01	52000188491	45	83 40 17	52000189168	50, 51, 56
75 11 10	52000193160	45	83 40 18	52000187006	50, 51, 56
75 11 11	52000193178	45	83 45 00	52000172917	50
75 11 20	52000192972	45	83 50 00	52000167339	50
75 11 90	52000183682	45	83 50 05	52000167859	50
75 12 20	52000192980	45	83 50 10	52000168329	50
75 12 90	52000184623	45	83 60 00	52000166786	50
75 16 20	52000193053	45	83 60 10	52000166554	50
75 16 90	52000184664	45	83 60 80	52000171570	50
75 17 20	52000193061	45	83 70 00	52000167149	50
75 17 90	52000187188	45	83 70 10	52000190125	50
75 18 20	52000193079	45	83 70 20	52000171588	50
75 18 90	52000188731	45	83 70 80	52000171596	50
75 19 20	52000193087	45	83 71 10	52000192477	50
75 19 90	52000188756	45	83 71 20	52000192485	50
75 20 20	52000193095	45	83 72 42	52000177346	50
75 20 90	52000188772	45	83 73 01	52000194093	50
75 21 20	52000193103	45	83 75 42	52000192493	50
75 21 90	52000188798	45	83 76 20	52000166679	50
75 22 20	52000193111	45	83 76 21	52000166901	50
75 22 90	52000191057	45	83 76 30	52000194077	50
75 24 20	52000193137	45	83 76 31	52000194085	50
75 24 90	52000191073	45	83 77 10	52000193962	50
75 25 20	52000193145	45	83 77 30	52000193970	50
75 25 90	52000191081	45	83 77 31	52000193988	50
75 26 20	52000193152	45	83 78 10	52000194036	50
75 26 90	52000191123	45	83 78 30	52000194044	50
75 27 20	52000195009	45	83 78 31	52000194051	50
75 27 90	52000195017	45	83 80 20	52000167842	50
77 20 00	52000183690	45	83 80 31	52000194119	50
77 20 01	52000184672	45	84 77 20	52000194002	56
77 60 00	52000183666	45	85 21 53	52000168022	51
77 70 00	52000183674	45	85 21 54	52000200239	51
77 70 70	52000183708	45	85 21 55	52000168006	51

Product Index

Part No	3M ID No	Page
85 30 56	52000167651	57
85 30 62	52000166919	51
85 30 64	52000187014	51
85 70 00	52000167040	51
85 77 20	52000194010	56
89 10 13	52000167602	57
89 10 14	52000193608	43, 54
89 60 50	52000167636	58
89 60 55	52000191347	55
89 60 72	52000167628	58
89 90 25	52000166398	57
89 90 35	52000165424	57
89 90 40	52000166950	57
89 90 41	52000169616	57
89 90 45	52000167644	57
89 90 51	52000167404	57
89 90 60	52000166752	57
89 91 35	52000165549	57
89 91 40	52000167453	57
89 91 41	52000169624	57
89 91 45	52000168162	57
89 91 51	52000168360	57
ACU-01	52000045303	52
ACU-02	52000045311	52
BT-20	52000052036	56
BT-30	52000052523	56
BT-40	52000052606	56
CMF-09	52000045048	60
FSL-22	52000044900	60
FSL-23	52000044918	60
G3001NUV-VI	XH001675236	48
H31P3AF	XA007702583	55, 56
H510P3AF-405GU	XA007702591	55, 56
H520P3AF-410GQ	XA007702609	55, 56
H540P3AF-413SV	XA007702625	55, 56
HNS-14	52000044892	60
HT-622	52000045410	60
HT-629	52000045428	60
HT-639	52000045436	60
HTS-19	52000044926	60
M-107	70071564150	56
M-116	70071564168	56
M-150	70071564176	56
M-154	70071564184	56
M-307	70071564200	56
M-316	70071564218	56
M-350	70071564226	55, 56

Part No	3M ID No	Page
M-354	70071564234	56
M-919	70071564309	56
M-920	70071564317	56
M-921	70071564325	56
M-927	70071564333	56
M-928	70071564341	56
M-937	70071564374	56
M-953	52000183096	56
M-956	70071564382	56
M-958	52000018292	56
M-960	70071564390	56
M-972	70071564408	56
M-976	70071564416	56
TR-325	52000052531	51
V-500E	52000052705	51
VIS-21	52000045469	60
VIS-22	52000045477	60
VIS-23	52000045485	60
VIS-24	52000145493	60
WLD-08	52000044934	60
WLD-10	52000045030	60
WLD-11	5200045055	60
WLD-12	52000045063	60
WLD-13	52000045089	60
WLD-15	52000045055	60
WLN-13	52000044959	60
WLN-14	52000045006	60
WLN-15	52000045022	60
WLN-17	52000045014	60
WLN-20	52000145501	60



The Power to Protect Your WorldSM

We are here to help you find the best solution for your safety challenge.

3M is the innovation company that never stops inventing...

As one of the world's leading suppliers of safety and protective equipment our goal is to ensure that we satisfy your needs through the provision of exceptional leadership, expertise, quality and service excellence. If we can make your life easier, healthier, safer and more productive we are moving in the right direction.

We serve as a beacon to those who aspire to make a profound, positive and lasting impact on workplace health and safety. 3M is at the forefront of product innovation giving you the confidence and power to help your world.

3M safety brands include:



PELTOR™

3M™ Peltor™ Hearing Protection and Communication Headsets



3M™ EAR™
Hearing Protection



Speedglas™

3M™ Speedglas™
Welding Protection Equipment

To view our customer testimonials visit:
www.youtube.com/user/3MHealthSafety.

A screenshot of the YouTube channel page for '3M Global PPE Safety Solutions'. The page features a banner with the text 'The Power to Protect Your World' and the 3M logo. Below the banner, there are navigation links for 'GLOBAL | The Americas | Europe | The Middle East & Africa | Asia & The Pacific'. The channel name '3M Global PPE Safety Solutions' is displayed, along with 122 subscribers and 45,674 videos. The page shows a list of videos under the heading 'Spellistor (13)'. The first video is 'Communications Headsets' with 2 video clips. The second video is 'PPE Safety Technical Support Videos' with 41 video clips. The third video is 'PPE Safety Talk' with 8 video clips.

Inspired by your reality

We have a passion for welding and we know the challenges of your profession. It comes natural for us to share the pride and concern you put into your work to address the ergonomic and safety issues facing you every day. Your thoughts and opinions are the bottom line in our continuous search for innovation. Inspired by your reality, we shape the the future of welding so you can get on with the job of shaping ours.

Join the welding community at Facebook/speedglas.



 Speedglas™

Learn. Share. Innovate.

3M

3M Svenska AB

Personal Safety Division

SE-785 21 Gagnef, Sweden

www.3M.eu/speedglas

www.youtube.com/3MSpeedglas

www.facebook.com/Speedglasglobal

3M, Speedglas Adflo, Versaflo and Peltor are trademarks of 3M.

Please recycle. Printed in Sweden.

© 3M 2013. All rights reserved.